

WDD15 SERIES

DC - DC CONVERTER
12 ~ 15W SINGLE & DUAL OUTPUT



FEATURES

- EFFICIENCY UP TO 84%
- 4:1 WIDE INPUT RANGE
- I/O ISOLATION
- INPUT Pi FILTER
- SHORT CIRCUIT PROTECTION
- HIGH PERFORMANCE
- 3 YEARS WARRANTY

MODEL LIST

MODEL NO.	INPUT VOLTAGE	INPUT CURRENT (typ.)	OUTPUT WATTAGE	OUTPUT VOLTAGE	OUTPUT CURRENT	EFF. (min.)	EFF. (typ.)	CAPACITOR LOAD (max.)
Single Output Models								
WDD15 - 03S4	10~36 VDC	0.63 A	12 WATTS	+3.3 VDC	3600 mA	77%	80%	7000 μ F
WDD15 - 05S4	10~36 VDC	0.78 A	15 WATTS	+ 5 VDC	3000 mA	79%	81%	7000 μ F
WDD15 - 12S4	10~36 VDC	0.75 A	15 WATTS	+ 12 VDC	1250 mA	81%	83%	470 μ F
WDD15 - 15S4	10~36 VDC	0.75 A	15 WATTS	+ 15 VDC	1000 mA	81%	83%	220 μ F
WDD15 - 03S5	18~72 VDC	0.32 A	12 WATTS	+3.3 VDC	3600 mA	77%	80%	7000 μ F
WDD15 - 05S5	18~72 VDC	0.39 A	15 WATTS	+ 5 VDC	3000 mA	79%	81%	7000 μ F
WDD15 - 12S5	18~72 VDC	0.37 A	15 WATTS	+ 12 VDC	1250 mA	82%	84%	470 μ F
WDD15 - 15S5	18~72 VDC	0.38 A	15 WATTS	+ 15 VDC	1000 mA	80%	82%	220 μ F
Dual Output Models								
WDD15 - 12D4	10~36 VDC	0.78 A	15 WATTS	\pm 12 VDC	\pm 630 mA	80%	82%	\pm 1000 μ F
WDD15 - 15D4	10~36 VDC	0.78 A	15 WATTS	\pm 15 VDC	\pm 500 mA	79%	81%	\pm 1000 μ F
WDD15 - 12D5	18~72 VDC	0.39 A	15 WATTS	\pm 12 VDC	\pm 630 mA	80%	82%	\pm 1000 μ F
WDD15 - 15D5	18~72 VDC	0.38 A	15 WATTS	\pm 15 VDC	\pm 500 mA	79%	81%	\pm 1000 μ F

SPECIFICATION

All Specifications Typical At Nominal Line, Full Load, 25°C Unless Otherwise Noticed

GENERAL						
Characteristics	Conditions		min.	typ.	max.	unit
Switching frequency	Vi nom, Io nom			230		KHz
Isolation voltage	Input - Output		1,500			VDC
Isolation resistance	Input - Output, @ 500VDC		100			MΩ
Isolation capacitance	100KHz / 1V				1,000	PF
Ambient temperature	Vi nom,	3.3V & 5V output models	-25		+ 61	°C
	Io nom	12V, 15V & dual output models	-25		+ 71	°C
Case temperature	Operating at Vi nom, Io nom				+ 100	°C
Derating	Vi nom		See derating curve			
Storage temperature	Non operational		-40		+ 100	°C
Relative humidity	Vi nom, Io nom		20		95	% RH
Temperature coefficient	Vi nom, Io min				± 0.02	% / °C
Dimension			L50.8 x W40.64 x H10.16			mm
MTBF	Bellcore issue 6@40°C, GB			1,270,000		Hours
Cooling	Free air convection					

INPUT SPECIFICATIONS						
Characteristics	Conditions		min.	typ.	max.	unit
Input voltage range	Ta min ... Ta max, Io nom		10	24	36	VDC
			18	48	72	VDC
No load input current	Vi nom, Io = 0	24V		15	mA	
		48V		10	mA	
Input voltage w/o damage	Io nom	24V		40	VDC	
		48V		75	VDC	
Startup voltage	Io nom	24V		9.5	VDC	
		48V		16	VDC	
Input filter	Pi type					

OUTPUT SPECIFICATIONS						
Characteristics	Conditions		min.	typ.	max.	unit
Output voltage accuracy	Vi nom, Io nom				± 2	%
Minimum load	Vi nom	single output models	0			%
		dual output models (each output)	10			%
Line regulation	Io nom, Vi min ... Vi max				± 1	%
Load regulation	Vi nom, Io 0 ... Io nom, single output models				± 2	%
	Vi nom, Io min ... Io nom, dual output models				± 5	%
Cross regulation (Dual model)	Aymmetrical load 10% - 100% FL				± 5	%
Startup time	Vi nom, Io nom				30	ms
Transient recovery time	Vi nom, 1 ~ 0.5 Io nom				500	μs
Ripple & noise	Vi nom, Io nom, BW = 20MHz	3.3V & 5V			100	mV
		12V, 15V & dual			150	mV
Voltage trim range 1)	Vi nom	3.3V		± 5		%
		5V, 12V, 15V & dual		± 10		%
Efficiency	Vi nom, Io nom, Po / Pi		Up to 84%, See model list and efficiency curve			

NOTE 1 : Pls refer to Fig 1 & Table 1 for connection and resistance recommended.

CONTROL AND PROTECTION	
Remote ON / OFF	ON : opened or 8 ~ 10VDC applied, reference to input GND OFF : -0.3 ~ 2VDC applied, reference to input GND
Input reversed	Shunt diode built in, external fuse recommended (24Vin : 2A, 48Vin : 1A)
Output short circuit	Current limited (Auto-recovery)
Rated over load protection	110%min....140%max

PHYSICAL CHARACTERISTICS

Case size	50.8 x 40.64 x 10.16 mm (2 x 1.6 x 0.4 inches)
Case material	Plastic base / Metal case
Weight	60 g
Potting material	Epoxy

MECHANISM & PIN CONFIGURATION

mm [inch]

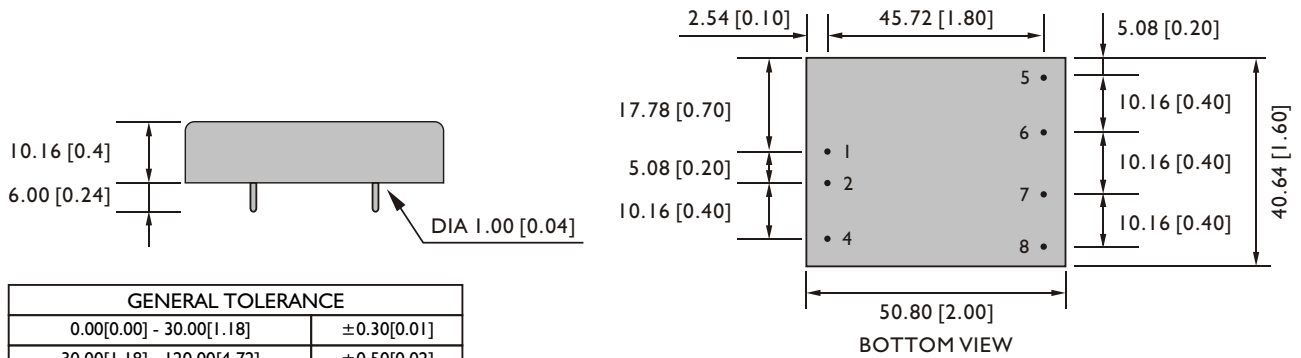

GENERAL TOLERANCE	
0.00[0.00] - 30.00[1.18]	±0.30[0.01]
30.00[1.18] - 120.00[4.72]	±0.50[0.02]

PIN ASSIGNMENT

GENERAL

PIN NO.	1	2	4	5	6	7	8
SINGLE	Vi+	Vi-	ON / OFF	NO PIN	Vo+	Vo-	Trim
DUAL	Vi+	Vi-	ON / OFF	Vo+	com	Vo-	Trim

CIRCUIT SCHEMATIC

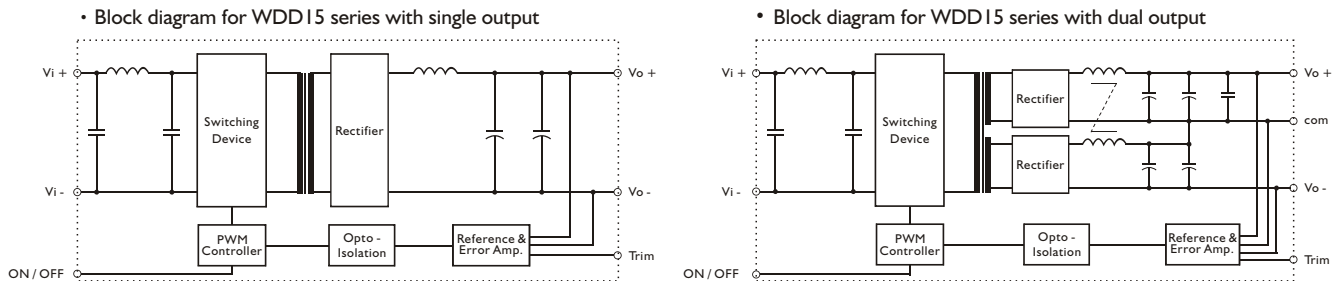

RECOMMENDED CIRCUIT

• Recommended filter for EN55022 Class B compliance

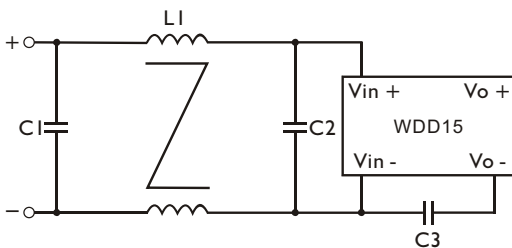

• The components used in the above figure, together with the manufacturer part numbers for these components, are as follows.

	C1	C2	C3	L1
WDD15-XXX4	1 μ F / 50V MLCC	1 μ F / 50V MLCC	1nF / 2KV MLCC	1.5mH Common Choke
WDD15-XXX5	3.3 μ F / 100V MLCC	3.3 μ F / 100V MLCC	1nF / 2KV MLCC	3.5mH Common Choke

• Recommended EN 55022 Class B filter circuit layout.

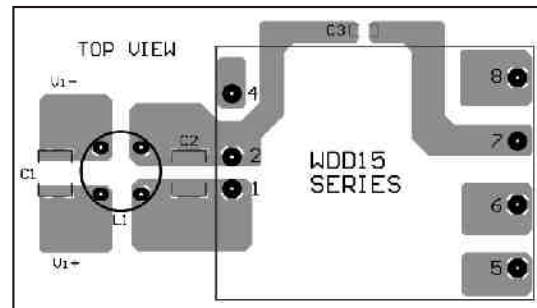

DERATING AND EFFICIENCY CURVE

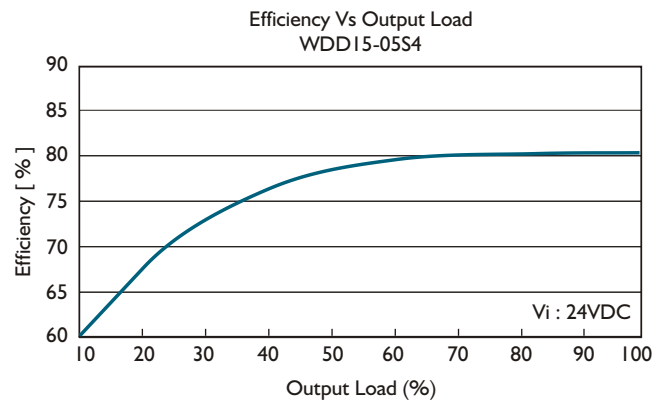
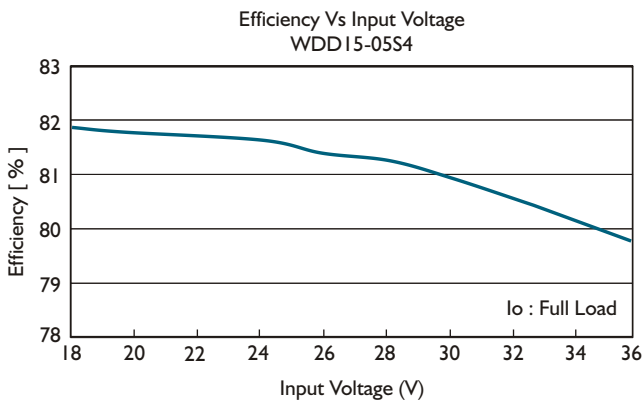
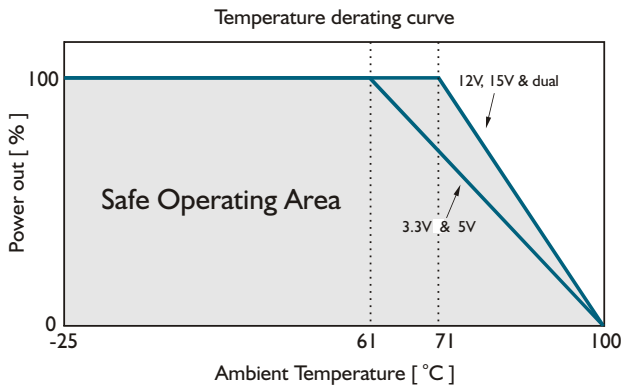
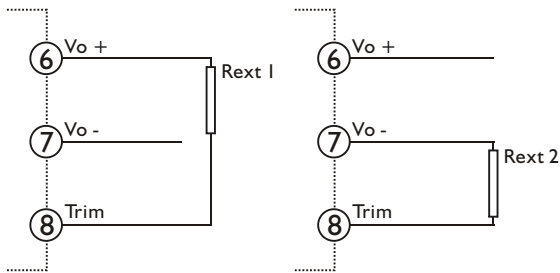

Fig. 1 Trim connection

(For Single output)



(For Dual output)

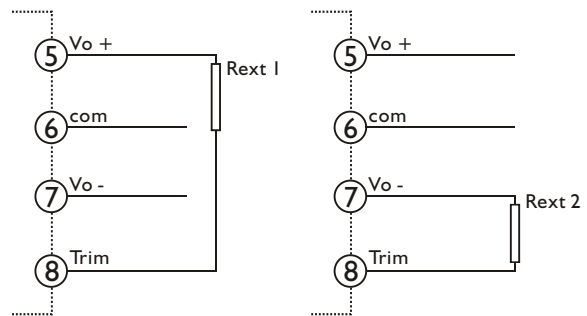

Table 1 Typical resistor values for various output voltage adjustment settings

Type	Rext 1		Rext 2	
	Vo nom -2.5%	Vo nom -5%	Vo nom +2.5%	Vo nom +5%
WDD15-03SX	750Ω	510Ω	8.66KΩ	3.9KΩ
Type	Vo nom -5%	Vo nom -10%	Vo nom +5%	Vo nom +10%
WDD15-05SX	4.7KΩ	0Ω	4.7KΩ	470Ω
WDD15-12SX	47KΩ	15KΩ	5.6KΩ	200Ω
WDD15-15SX	150KΩ	56KΩ	12KΩ	1KΩ
WDD15-12DX	130KΩ	51KΩ	10KΩ	750Ω
WDD15-15DX	330KΩ	150KΩ	20KΩ	3KΩ