



### FEATURES:

- RoHS compliant
- 2:1 input range
- Low ripple and noise
- Remote On/Off control
- Synchronous rectifier
- Power modules for PCB mounting
- Regulated output
- Operating temperature range: -40 to +85°C
- Capacitive loading up to 41000  $\mu$ F (36-75V input)



### Models Single output

Model	Input Voltage (V)	Output Voltage (V)	Output Current max (A)	Ripple & Noise typ	Isolation (VDC)	Efficiency (%)
AM15E-1203SIZ	9-18	3.3	4	80mV p-p	1500	79
AM15E-1205SIZ	9-18	5	3	80mV p-p	1500	83
AM15E-1212SIZ	9-18	12	1.25	120mVp-p	1500	85
AM15E-1215SIZ	9-18	15	1	150mVp-p	1500	85
AM15E-2403SIZ	18-36	3.3	4	80mV p-p	1500	81
AM15E-2405SIZ	18-36	5	3	80mV p-p	1500	83
AM15E-2412SIZ	18-36	12	1.25	120mVp-p	1500	88
AM15E-2415SIZ	18-36	15	1	150mVp-p	1500	87
AM15E-4803SIZ	36-75	3.3	4	80mV p-p	1500	81
AM15E-4805SIZ	36-75	5	3	80mV p-p	1500	83
AM15E-4812SIZ	36-75	12	1.25	120mVp-p	1500	88
AM15E-4815SIZ	36-75	15	1	150mVp-p	1500	87
<b>SH30IZ</b>						
AM15E-1203SH30IZ	9-18	3.3	4	80mV p-p	3000	74
AM15E-1205SH30IZ	9-18	5	3	80mV p-p	3000	78
AM15E-1212SH30IZ	9-18	12	1.25	120mVp-p	3000	82
AM15E-1215SH30IZ	9-18	15	1	150mVp-p	3000	83
AM15E-2403SH30IZ	18-36	3.3	4	80mV p-p	3000	75
AM15E-2405SH30IZ	18-36	5	3	80mV p-p	3000	77
AM15E-2412SH30IZ	18-36	12	1.25	120mVp-p	3000	84
AM15E-2415SH30IZ	18-36	15	1	150mVp-p	3000	83
AM15E-4803SH30IZ	36-75	3.3	4	80mV p-p	3000	75
AM15E-4805SH30IZ	36-75	5	3	80mV p-p	3000	76
AM15E-4812SH30IZ	36-75	12	1.25	120mVp-p	3000	85
AM15E-4815SH30IZ	36-75	15	1	150mVp-p	3000	85

### Models Dual output

Model	Input Voltage (V)	Output Voltage (V)	Output Current max (A)	Ripple & Noise typ	Isolation (VDC)	Efficiency (%)
AM15E-1205DIZ	9-18	$\pm$ 5	$\pm$ 1.5	50mVp-p	1500	85
AM15E-1212DIZ	9-18	$\pm$ 12	$\pm$ 0.62	120mVp-p	1500	85
AM15E-1215DIZ	9-18	$\pm$ 15	$\pm$ 0.5	150mVp-p	1500	85
AM15E-2405DIZ	18-36	$\pm$ 5	$\pm$ 1.5	50mVp-p	1500	83
AM15E-2412DIZ	18-36	$\pm$ 12	$\pm$ 0.62	120mVp-p	1500	88
AM15E-2415DIZ	18-36	$\pm$ 15	$\pm$ 0.5	150mVp-p	1500	87
AM15E-4805DIZ	36-75	$\pm$ 5	$\pm$ 1.5	50mVp-p	1500	83
AM15E-4812DIZ	36-75	$\pm$ 12	$\pm$ 0.62	120mVp-p	1500	88
AM15E-4815DIZ	36-75	$\pm$ 15	$\pm$ 0.5	150mVp-p	1500	87
<b>DH30IZ</b>						
AM15E-1205DH30IZ	9-18	$\pm$ 5	$\pm$ 1.5	50mVp-p	3000	78
AM15E-1212DH30IZ	9-18	$\pm$ 12	$\pm$ 0.62	120mVp-p	3000	82
AM15E-1215DH30IZ	9-18	$\pm$ 15	$\pm$ 0.5	150mVp-p	3000	81

## Models

### Dual output (continued)

Model	Input Voltage (V)	Output Voltage (V)	Output Current max (A)	Ripple & Noise typ	Isolation (VDC)	Efficiency (%)
AM15E-2405DH30IZ	18-36	±5	±1.5	50mVp-p	3000	80
AM15E-2412DH30IZ	18-36	±12	±0.62	120mVp-p	3000	82
AM15E-2415DH30IZ	18-36	±15	±0.5	150mVp-p	3000	84
AM15E-4805DH30IZ	36-75	±5	±1.5	50mVp-p	3000	76
AM15E-4812DH30IZ	36-75	±12	±0.62	120mVp-p	3000	83
AM15E-4815DH30IZ	36-75	±15	±0.5	150mVp-p	3000	85

NOTE: All specifications in this datasheet are measured at an ambient temperature of 25°C, humidity<75%, nominal input voltage and at rated output load unless otherwise specified.

## Input Specifications

Parameters	Nominal	Typical	Maximum	Units
Voltage range	12	9-18		VDC
	24	18-36		
	48	37-75		
Filter	π (Pi) Network			
Remote On/Off Control	On	3.5 to 12VDC or open circuit		
	Off	0 to 1.2VDC or short circuit between pin 2 and 4; typical idle current 3mA		
Absolute Maximum Rating	12 Vin		25	VDC
	24 Vin		50	
	48 Vin		100	
Permissible absolute maximum duration			2	h
Recommended Input Fuse (slow blow)	12 Vin	4A/250V		
	24 Vin	2A/250V		
	48 Vin	1A/250V		

## Isolation Specifications

Parameters	Conditions	Typical	Maximum	Units
Tested I/O voltage	3 sec	1500 & 3000		VDC
Resistance		> 1000		MOhm
Capacitance		1000		pF

## Output Specifications

Parameters	Conditions	Typical	Maximum	Units
Voltage accuracy		±2		%
Short Circuit protection	Continuous			
Short Circuit restart	Auto recovery			
Over voltage protection	Zener diode clamp protection			
Over load protection	Over 110% full load with auto-recovery			
Line voltage regulation (Single)	HL-LL	±0.5		%
Line voltage regulation (Dual)	HL-LL	±0.5		%
Load voltage regulation (Single)	25-100%	±0.5		%
Load voltage regulation (Dual)	25-100%	±2		%
Temperature coefficient		±0.05		%/°C
Transient response recovery time	25% load step change	300		uS

## General Specifications

Parameters	Conditions	Typical	Maximum	Units
Switching frequency	100% load	200		KHz
Operating temperature	With derating above +75		-40 to +75	°C
Storage temperature			-55 to +115	°C
Maximum Case temperature			95	°C
Cooling	Free air convection			
Humidity			95	%
Case material	Nickel coated copper			
Weight		33		g
Dimensions (L x W x H)		2.00 x 1.00 x 0.40 inches	50.80 x 25.40 x 10.50 mm	
MTBF		> 800 000 hrs (MIL-HDBK -217F, Ground Benign, t=+25°C)		

## Safety Specifications

Parameters	
Agency approvals	CE
Standards	EN 55022, EN 55024 class B

## Pin Out Specifications

Pin	Single	Dual
1	On/Off Control	On/Off Control
2	-V Input	-V Input
3	+V Input	+V Input
4	-V Output	-V Output
5	No pin	Common
6	+V Output	+V Output

## Derating

### 1500 vdc Isolation

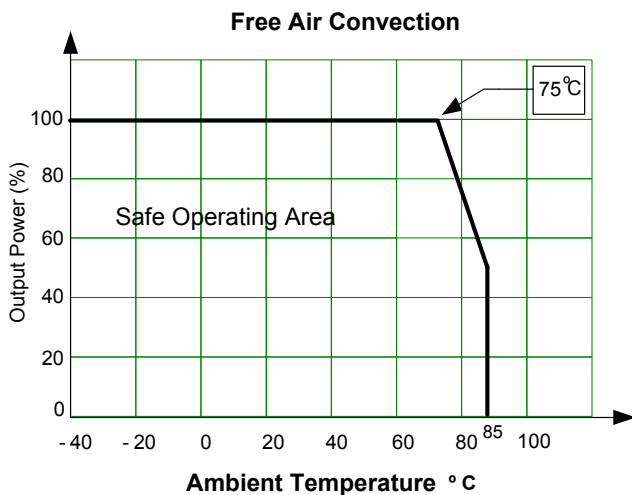

### 3000VDC Isolation

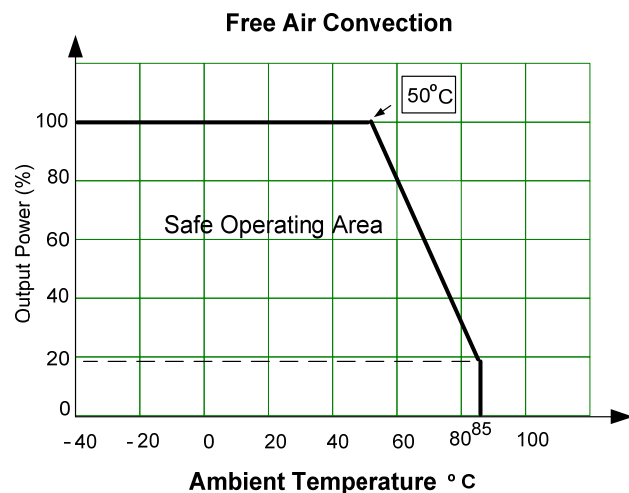

**Dimensions**

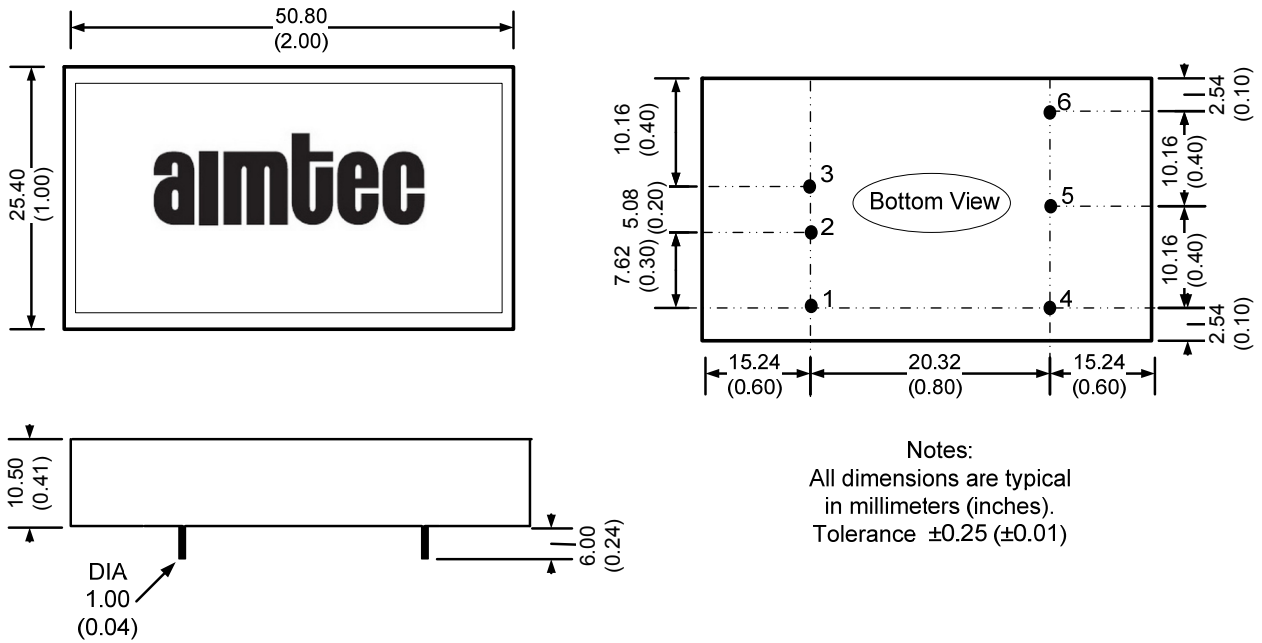

Notes:  
All dimensions are typical  
in millimeters (inches).  
Tolerance  $\pm 0.25$  ( $\pm 0.01$ )

**Block diagram**

**Single Output**

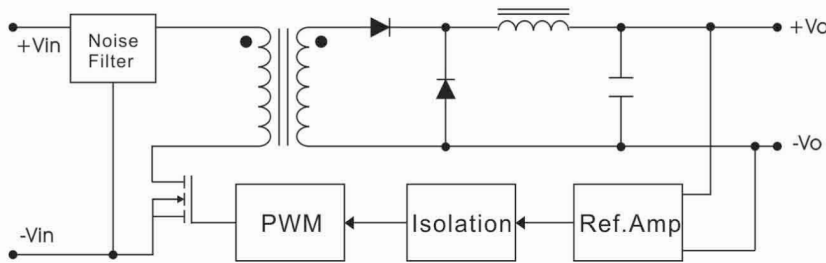

**Dual Output**

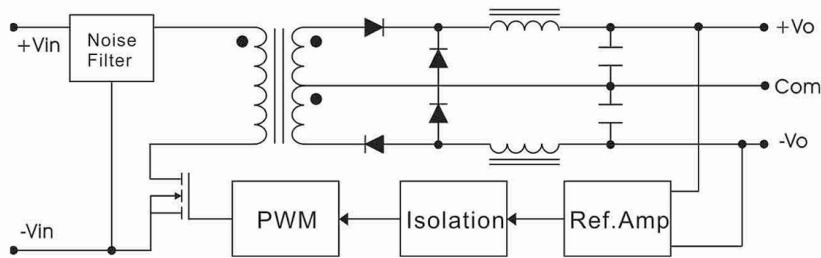

**Control ON/OFF pin connection example:**

**Single Output**

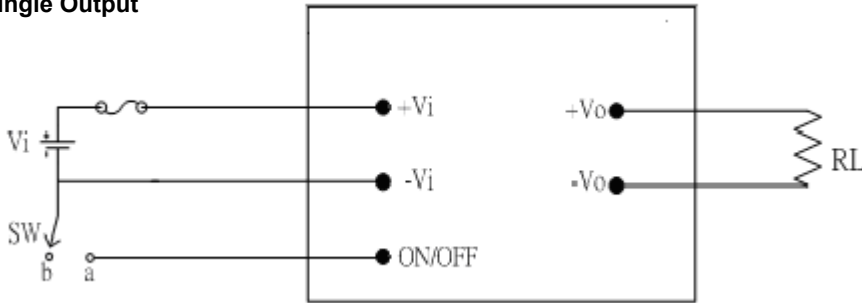

**Dual Output**

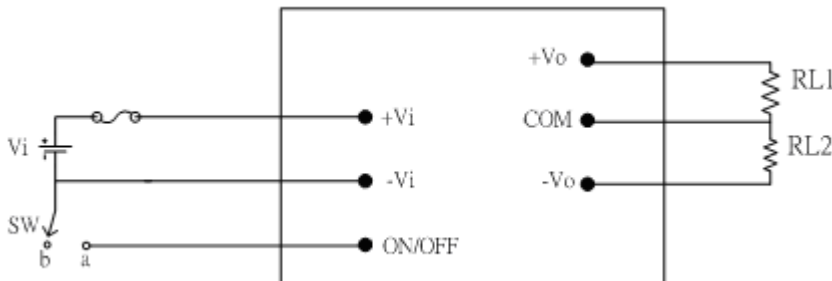

The converter output can be disabled by moving SW to position “a”. When SW is in position “b”, the converter operates normally. The SW can be replaced by a NPN transistor with connection as follows:

**Note: The control voltage is referenced to negative input (-Vi)**

**Digital Control Circuit:**

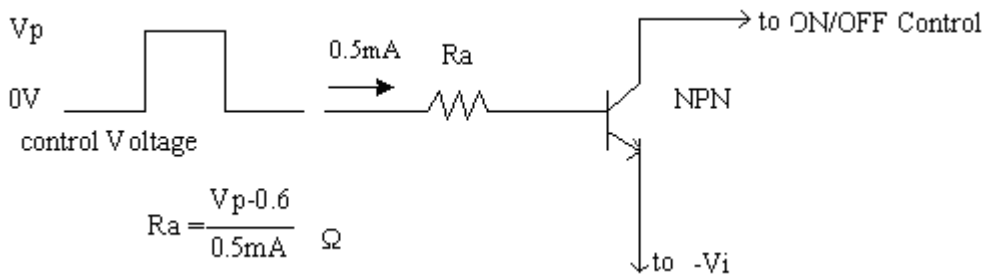

**NOTE:** 1. Datasheets are updated as needed and as such, specifications are subject to change without notice. Once printed or downloaded, datasheets are no longer controlled by Aimtec; refer to [www.aimtec.com](http://www.aimtec.com) for the most current product specifications. 2. Product labels shown, including safety agency certifications on labels, may vary based on the date manufactured. 3. Mechanical drawings and specifications are for reference only. 4. All specifications are measured at an ambient temperature of 25°C, humidity < 75%, nominal input voltage and at rated output load unless otherwise specified. 5. Aimtec may not have conducted destructive testing or chemical analysis on all internal components and chemicals at the time of publishing this document. CAS numbers and other limited information are considered proprietary and may not be available for release. 6. This product is not designed for use in critical life support systems, equipment used in hazardous environments, nuclear control systems or other such applications which necessitate specific safety and regulatory standards other than the ones listed in this datasheet. 7. Warranty is in accordance with Aimtec’s standard Terms of Sale available at [www.aimtec.com](http://www.aimtec.com).