

VI TELEFILTER

Filter specification

TFS 817

1/5

Measurement condition

| | | |
|--------------------------|------------------|-----|
| Ambient temperature: | 23 | °C |
| Input power level: | 0 | dBm |
| Terminating impedance: * | | |
| Input: | 357 Ω -2,5 pF | |
| Output: | 231 Ω -3,2 pF | |

Characteristics

Remark:

The reference level for the relative attenuation a_{rel} of TFS 817 is the minimum of the pass band attenuation a_{min} . This value is defined as the insertion loss a_e . The centre frequency f_c is the arithmetic mean value of the upper and lower frequencies at the 1 dB filter attenuation level relative to the insertion loss a_e . The given values for the relative attenuation a_{rel} and the group delay ripple have to be reached at the frequencies given below, even if the centre frequency f_c is shifted due to the temperature coefficient of frequency TC_f in the operating temperature range and due to a production tolerance for the centre frequency f_c .

| D a t a | | typ. value | | tolerance / limit | |
|---|------------|-------------------|-------|--------------------------|---------------------|
| Insertion loss (reference level) | a_e | 12,8 | dB | max. | 14 dB |
| Nominal frequency | f_N | | | | 817 MHz |
| Centre frequency | f_c | 817 | MHz | | |
| Passband | PB | - | | $f_N \pm$ | 53 MHz |
| Pass band ripple | | 0,6 | dB | max. | 1 dB |
| Amplitude ripple within any 150 kHz in PB | | 0,2 | dB | max. | 0,5 dB |
| Bandwidth 1 dB | BW | 118 | MHz | min. | 106 MHz |
| Relative attenuation | a_{rel} | | | | |
| 10 MHz ... 500 MHz | | 50 | dB | min. | 30 dB |
| 500 MHz ... 715 MHz | | 45 | dB | min. | 35 dB |
| 910 MHz ... 1150 MHz | | 41 | dB | min. | 35 dB |
| 1150 MHz ... 3000 MHz | | 55 | dB | min. | 30 dB |
| 3000 MHz ... 5000 MHz | | 65 | dB | min. | 15 dB |
| Absolute group delay within PB | | 115 | ns | | - |
| Group delay ripple within any 150kHz in PB | | 9 | ns | max. | 100 ns |
| Input return loss | | 11 | dB | min. | 8 dB |
| Output return loss | | 13 | dB | min. | 8 dB |
| Intermodulation | IP3 ** | - | | min. | 35 dBm |
| Input power level | | - | | max. | +10 dBm |
| Permissible DC voltage | | | | | |
| Operating temperature range | OTR | - | | | - 35 °C ... + 85 °C |
| Storage temperature range | | - | | | - 40 °C ... + 85 °C |
| Temperature coefficient of frequency | TC_f *** | -92 | ppm/K | | |

*) The terminating impedances depend on parasitics and q-values of matching elements and the board used, and are to be understood as reference values only. Should there be additional questions do not hesitate to ask for an application note or contact our design team.

**) Two tones +5dBm, 100kHz apart

***) $\Delta f(\text{Hz}) = TC_f(\text{ppm/K}) \times (T - T_0) \times f_{T0}(\text{MHz})$

Generated:

Checked / Approved:

Tele Filter GmbH
Potsdamer Straße 18
D 14 513 TELTOW / Germany
Tel: (+49) 3328 4784-0 / Fax: (+49) 3328 4784-30
E-Mail: tft@telefilter.com

VI TELEFILTER reserves the right to make changes to the product(s) and/or information contained herein without notice. No liability is assumed as a result of their use or application. No rights under any patent accompany the sale of any such product(s) or information.

Filter characteristic

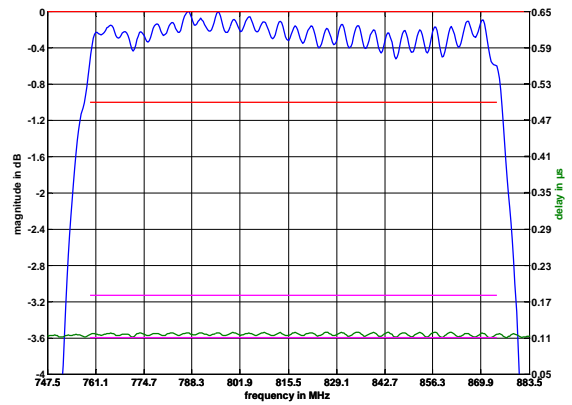
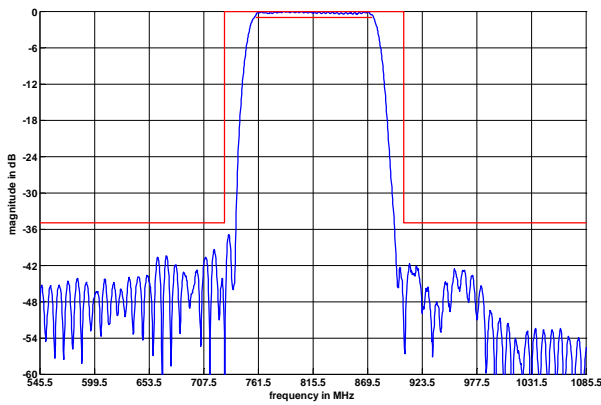

Construction and pin connection

(All dimensions in mm)

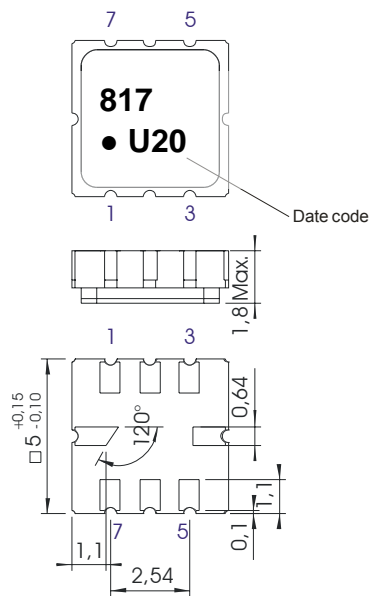

- 1 Input
- 2 Input RF Return
- 3 Ground
- 4 Ground
- 5 Output
- 6 Output RF Return
- 7 Ground
- 8 Ground

Date code: Year + week
 U 2006
 V 2007
 W 2008
 ...

50 Ohm Test circuit

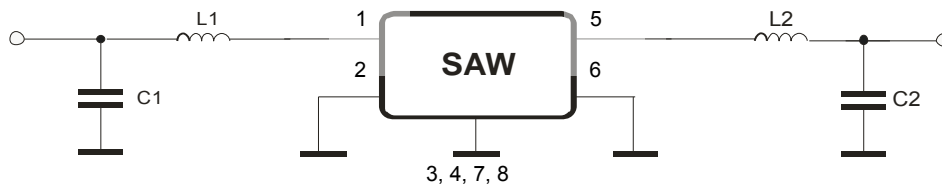

Tele Filter GmbH
 Potsdamer Straße 18
 D 14 513 TELTOW / Germany
 Tel: (+49) 3328 4784-0 / Fax: (+49) 3328 4784-30
 E-Mail: tft@telefilter.com

VI TELEFILTER reserves the right to make changes to the product(s) and/or information contained herein without notice. No liability is assumed as a result of their use or application. No rights under any patent accompany the sale of any such product(s) or information.

Stability characteristics

After the following tests the filter shall meet the whole specification:

1. Shock: 500g, 1 ms, half sine wave, 3 shocks each plane;
DIN IEC 68 T2 - 27
2. Vibration: 10 Hz to 500 Hz, 0,35 mm or 5 g respectively, 1 octave per min, 10 cycles per plan, 3 plans;
DIN IEC 68 T2 - 6
3. Change of temperature: -55 °C to 125°C / 30 min. each / 10 cycles
DIN IEC 68 part 2 – 14 Test N
4. Resistance to solder heat (reflow): reflow possible: twice max.;
for temperature conditions refer to the attached "Air reflow temperature conditions" on page 4;

This filter is RoHS compliant (2002/95/EG, 2005/618/EG)

Packing

Tape & Reel: IEC 286 – 3, with exception of value for N and minimum bending radius;
tape type II, embossed carrier tape with top cover tape on the upper side;

| | |
|---|-------------|
| max. pieces of filters per reel: | 3000 |
| reel of empty components at start: | min. 300 mm |
| reel of empty components at start including leader: | min. 500 mm |
| trailer: | min. 300 mm |

Tape (all dimensions in mm)

- W : 12,00 ± 0,3
- Po : 4,00 ± 0,1
- Do : 1,50 +0,1/-0
- E : 1,75 ± 0,1
- F : 5,50 ± 0,05
- G(min) : 0,75
- P2 : 2,00 ± 0,05
- P1 : 8,00 ± 0,1
- D1(min) : 1,50
- Ao : 5,30 ± 0,1
- Bo : 5,30 ± 0,1
- Ct : 9,5 ± 0,1

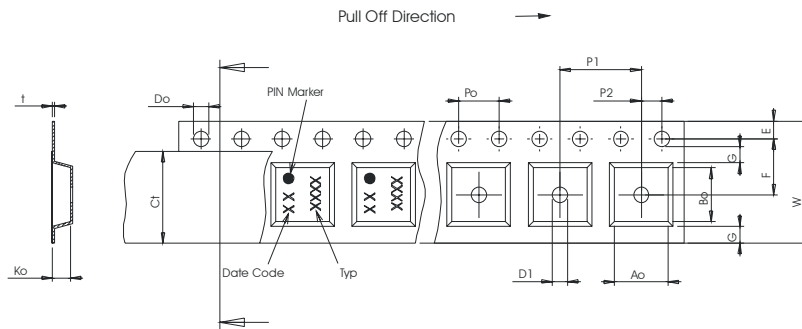

Reel (all dimensions in mm)

- A : 330
- W1 : 12,4 +2/-0
- W2(max) : 18,4
- N(min) : 50
- C : 13,0 +0,5/-0,2

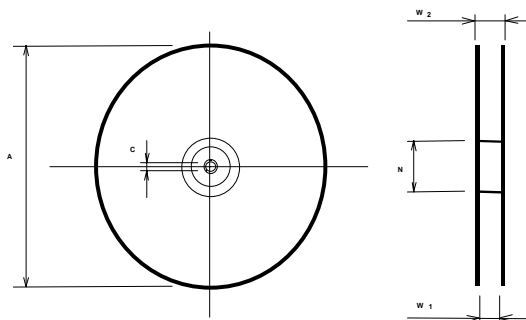

The minimum bending radius is 45 mm.

Tele Filter GmbH
Potsdamer Straße 18
D 14 513 TELTOW / Germany
Tel: (+49) 3328 4784-0 / Fax: (+49) 3328 4784-30
E-Mail: tft@telefilter.com

VI TELEFILTER reserves the right to make changes to the product(s) and/or information contained herein without notice. No liability is assumed as a result of their use or application. No rights under any patent accompany the sale of any such product(s) or information.

Air reflow temperature conditions

| Conditions | Exposure |
|--|-----------------------------|
| Average ramp-up rate (30°C to 217°C) | less than 3°C/second |
| > 100°C | between 300 and 600 seconds |
| > 150°C | between 240 and 500 seconds |
| > 217°C | between 30 and 150 seconds |
| Peak temperature | max. 260°C |
| Time within 5°C of actual peak temperature | between 10 and 30 seconds |
| Cool-down rate (Peak to 50°C) | less than 6°C/second |
| Time from 30°C to Peak temperature | no greater than 300 seconds |

Chip-mount air reflow profile

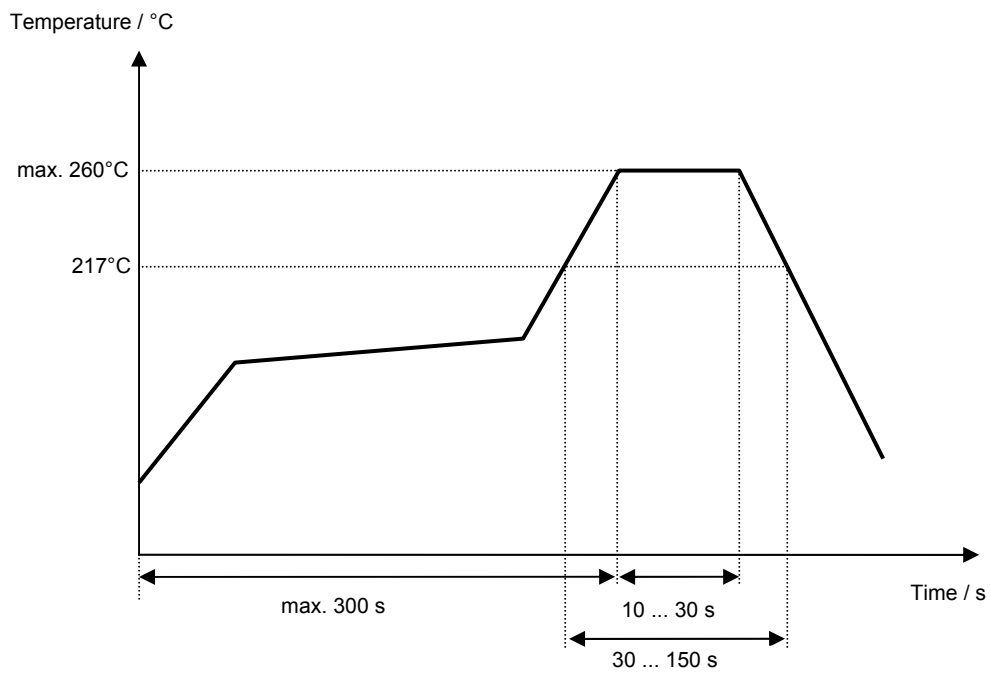

VI TELEFILTER**Filter specification****TFS 817****5/5****History**

| Version | Reason of Changes | Name | Date |
|----------------|---|-------------|-------------|
| 1.0 | Generation of development specification | Strehl | 09.05.2005 |
| 1.1 | - generated filter specification - added terminating impedances - added typical values - added filter characteristic - added test circuit | Chilla | 23.05.2006 |

Tele Filter GmbH
Potsdamer Straße 18
D 14 513 TELTOW / Germany
Tel: (+49) 3328 4784-0 / Fax: (+49) 3328 4784-30
E-Mail: tft@telefilter.com

VI TELEFILTER reserves the right to make changes to the product(s) and/or information contained herein without notice. No liability is assumed as a result of their use or application. No rights under any patent accompany the sale of any such product(s) or information.