

**Vectron International****Filter specification****TFS 611****1/5****Measurement condition**

Ambient temperature:	25	°C
Input power level:	0	dBm
Terminating impedance: *		
Input:	250 Ω	-4,5 pF
Output:	210 Ω	-4,6 pF

**Characteristics**

## Remark:

The reference level for the relative attenuation  $a_{rel}$  of the TFS 611 is the minimum of the pass band attenuation  $a_{min}$ . The minimum of the pass band attenuation  $a_{min}$  is defined as the insertion loss  $a_e$ . The centre frequency  $f_C$  is the arithmetic mean value of the upper and lower frequencies at the 3 dB filter attenuation level relative to the insertion loss  $a_e$ . The nominal frequency  $f_N$  is fixed at 611,0 MHz without any tolerance. The given values for both the relative attenuation  $a_{rel}$  and the group delay ripple have to be achieved at the frequencies given below even if the centre frequency  $f_C$  is shifted due to the temperature coefficient of frequency  $TC_f$  in the operating temperature range and due to a production tolerance for the centre frequency  $f_C$ .

<b>D a t a</b>		<b>typ. value</b>		<b>tolerance / limit</b>	
<b>Insertion loss at ambient temperature</b> (reference level)	$a_e$	5,6	dB	max.	6 dB
<b>Nominal frequency</b>	$f_N$	-			611 MHz
<b>Centre frequency at ambient temperature</b>	$f_C$	611,0	MHz	±	0,5 MHz
<b>Relative attenuation</b>	$a_{rel}$				
$f_C$	... $f_C$ ± 3 MHz	0,5	dB	max.	1 dB
$f_C$ ± 3 MHz	... $f_C$ ± 3,5 MHz	1,5	dB	max.	3 dB
$f_C$ ± 4 MHz	... $f_C$ ± 9 MHz	5	dB	min.	3 dB
$f_C$ ± 9 MHz	... $f_C$ ± 100 MHz	47	dB	min.	40 dB
$f_C$ ± 100 MHz	... $f_C$ ± 500 MHz	60	dB	min.	50 dB
<b>Operating temperature range</b>	OTR	-			- 40 °C ... + 85 °C
<b>Storage temperature range</b>		-			- 40 °C ... + 85 °C
<b>Temperature coefficient of frequency</b>	$TC_f$ **	-18	ppm/K		-

\*) The terminating impedances depend on parasitics and q-values of matching elements and the board used, and are to be understood as reference values only. Should there be additional questions do not hesitate to ask for an application note or contact our design team.

\*\*\*)  $\Delta f_C$  (Hz) =  $TC_f$ (ppm/K) × (T<sub>0</sub> - T<sub>A</sub>) × f<sub>cat</sub>(MHz)

**Generated:****Checked / Approved:****Vectron International GmbH & Co. KG****Potsdamer Straße 18****D 14 513 TELTOW / Germany****Tel: (+49) 3328 4784-0 / Fax: (+49) 3328 4784-30****E-Mail: [fft@vectron.com](mailto:fft@vectron.com)**

Vectron International GmbH & Co. KG reserves the right to make changes to the product(s) and/or information contained herein without notice. No liability is assumed as a result of their use or application. No rights under any patent accompany the sale of any such product(s) or information.

Filter characteristic

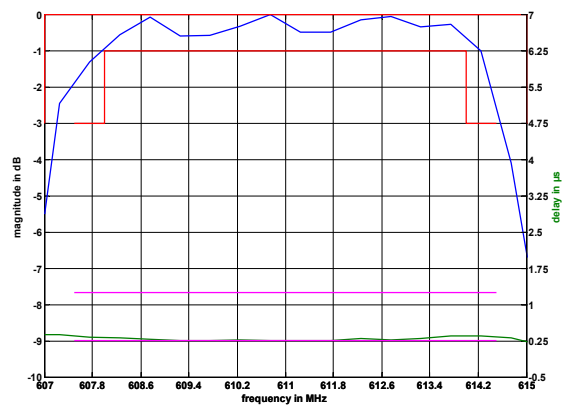
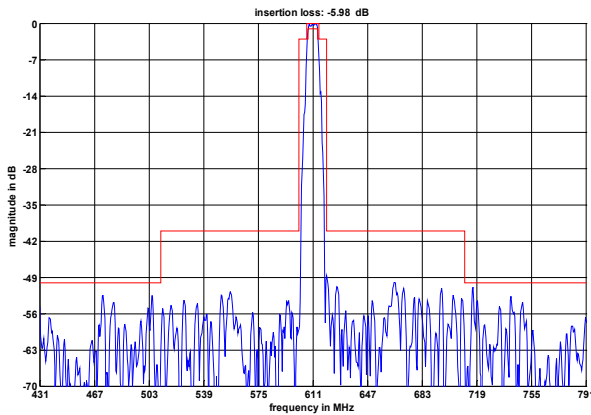

Construction and pin connection

(All dimensions in mm)

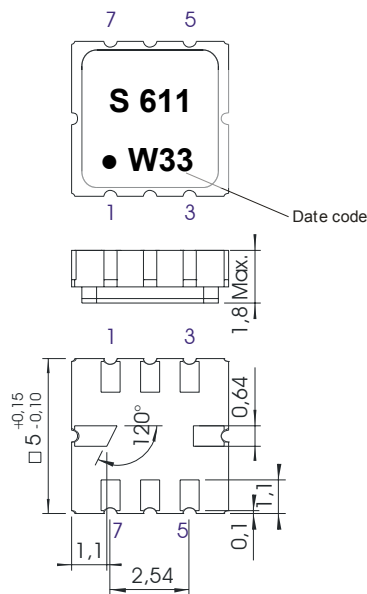

- 1 Input
- 2 Input RF Return
- 3 Ground
- 4 Ground
- 5 Output
- 6 Output RF Return
- 7 Ground
- 8 Ground

Date code: Year + week  
 W 2008  
 X 2009  
 A 2010  
 ...

50 Ω Test circuit

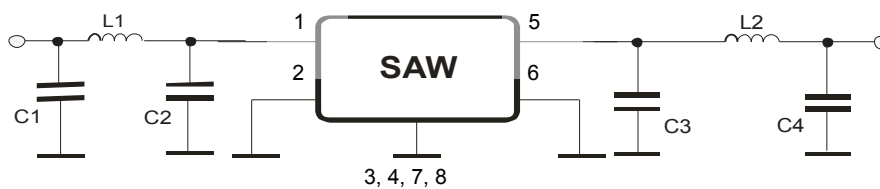

Vectron International GmbH & Co. KG  
 Potsdamer Straße 18  
 D 14 513 TELTOW / Germany  
 Tel: (+49) 3328 4784-0 / Fax: (+49) 3328 4784-30  
 E-Mail: [tft@vectron.com](mailto:tft@vectron.com)

Vectron International GmbH & Co. KG reserves the right to make changes to the product(s) and/or information contained herein without notice. No liability is assumed as a result of their use or application. No rights under any patent accompany the sale of any such product(s) or information.

**Stability characteristics, reliability**

After the following tests the filter shall meet the whole specification:

- 1. Shock: 500g, 1 ms, half sine wave, 3 shocks each plane;  
DIN IEC 68 T2 - 27
- 2. Vibration: 10 Hz to 500 Hz, 0,35 mm or 5 g respectively, 1 octave per min, 10 cycles per plan, 3 plans;  
DIN IEC 68 T2 - 6
- 3. Change of temperature: -55 °C to 125°C / 30 min. each / 10 cycles  
DIN IEC 68 part 2 – 14 Test N
- 4. Resistance to solder heat (reflow): reflow possible: three times max.;  
for temperature conditions refer to the attached "Air reflow temperature conditions" on page 4;

- 5. ESD MIL-STD-883E using coupling network of ISO 10605 and EN 6100-4-2  
HBM:250V; CDM:V;

This filter is RoHS compliant (2002/95/EG, 2005/618/EG)

**Packing**

Tape & Reel: IEC 286 – 3, with exception of value for N and minimum bending radius;  
tape type II, embossed carrier tape with top cover tape on the upper side;

max. pieces of filters per reel:	3000
reel of empty components at start:	min. 300 mm
reel of empty components at start including leader:	min. 500 mm
trailer:	min. 300 mm

**Tape (all dimensions in mm)**

- W : 12,00
- Po : 4,00
- Do : 1,50
- E : 1,75
- F : 5,50
- G(min) : 0,75
- P2 : 2,00
- P1 : 8,00
- D1(min) : 1,50
- Ao : 5,30
- Bo : 5,30
- Ct : 9,5

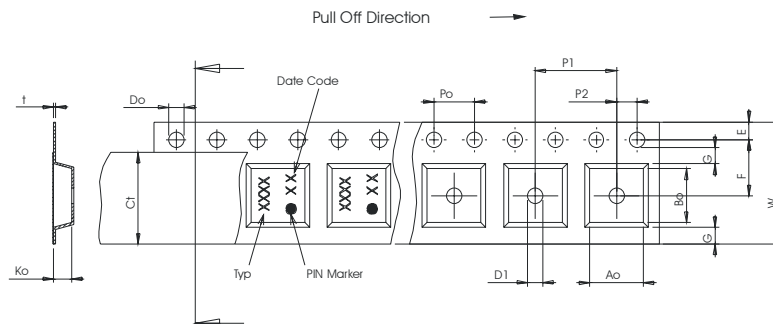

**Reel (all dimensions in mm)**

- A : 330
- W1 : 12,4
- W2(max) : 18,4
- N(min) : 50
- C : 13,0

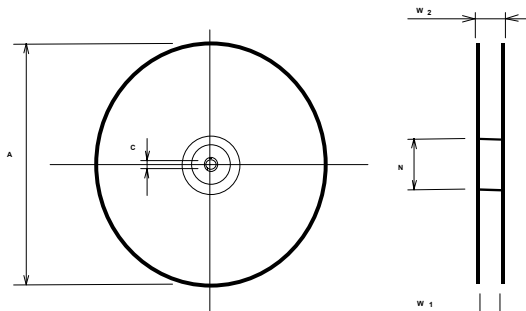

The minimum bending radius is 45 mm.

**Vectron International GmbH & Co. KG**  
**Potsdamer Straße 18**  
**D 14 513 TELTOW / Germany**  
**Tel: (+49) 3328 4784-0 / Fax: (+49) 3328 4784-30**  
**E-Mail: [tft@vectron.com](mailto:tft@vectron.com)**

Vectron International GmbH & Co. KG reserves the right to make changes to the product(s) and/or information contained herein without notice. No liability is assumed as a result of their use or application. No rights under any patent accompany the sale of any such product(s) or information.

**Air reflow temperature conditions**

<b>Conditions</b>	<b>Exposure</b>
Average ramp-up rate (30°C to 217°C)	less than 3°C/second
> 100°C	between 300 and 600 seconds
> 150°C	between 240 and 500 seconds
> 217°C	between 30 and 150 seconds
Peak temperature	max. 260°C
Time within 5°C of actual peak temperature	between 10 and 30 seconds
Cool-down rate (Peak to 50°C)	less than 6°C/second
Time from 30°C to Peak temperature	no greater than 300 seconds

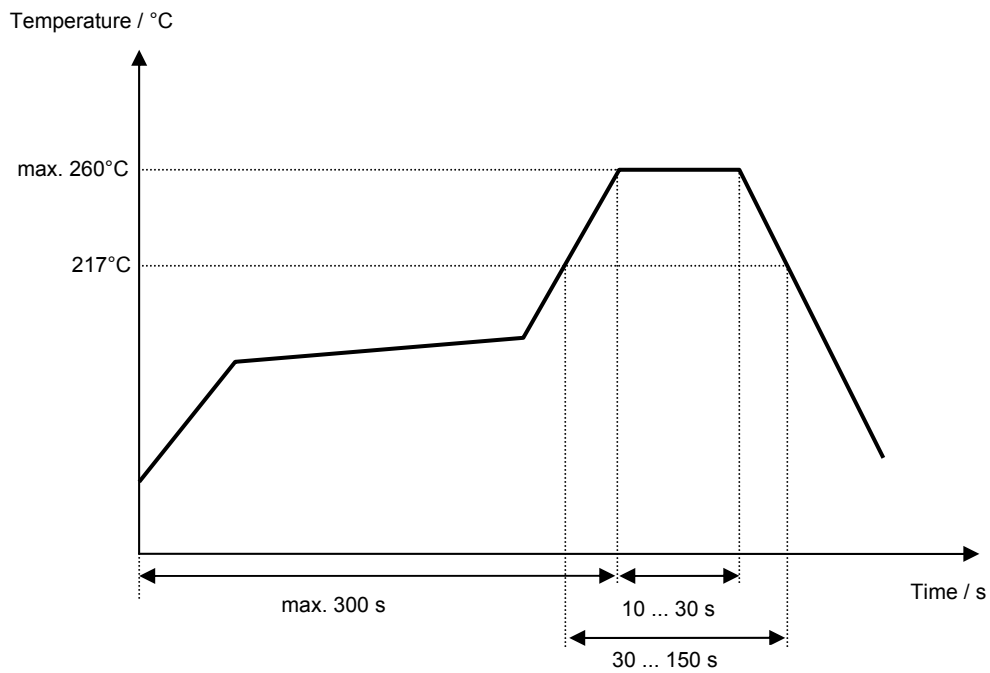
**Chip-mount air reflow profile**

**Vectron International GmbH & Co. KG**

Potsdamer Straße 18

D 14 513 TELTOW / Germany

Tel: (+49) 3328 4784-0 / Fax: (+49) 3328 4784-30

E-Mail: [tft@vectron.com](mailto:tft@vectron.com)

Vectron International GmbH & Co. KG reserves the right to make changes to the product(s) and/or information contained herein without notice. No liability is assumed as a result of their use or application. No rights under any patent accompany the sale of any such product(s) or information.

**History**

<b>Version</b>	<b>Reason of Changes</b>	<b>Name</b>	<b>Date</b>
1.0	generation of specification	Pfeiffer	24.03.2003
1.1	revised according to customer requirements	Steiner	23.07.2003
1.2	terminating impedance, typical values and matching configuration added	Pfeiffer	13.01.2004
1.3	change OTR and stability characteristics add filter characteristics	Strehl	14.08.2008