

VI TELEFILTER**Filter specification****TFS 552A****1/5****Measurement condition**

Ambient temperature:	23	°C
Input power level:	0	dBm
Terminating impedance: *		
Input:	177 Ω	-6.3 pF
Output:	57 Ω	-10.6 pF

Characteristics

Remark:

The reference level for the relative attenuation a_{rel} of the TFS 552A is the minimum of the pass band attenuation. This value is defined as the insertion loss a_e . The nominal frequency f_N is fixed at 552 MHz without any tolerance. The values of relative attenuation a_{rel} are guaranteed for the whole operating temperature range. The frequency shift of the filter in the operating temperature range is included in the production tolerance scheme.

D a t a		typ. Value		tolerance / limit	
Insertion loss within PB (reference level)	a_e	13.5	dB	max.	17,0 dB
Nominal frequency	f_N				552,0 MHz
Centre frequency	f_C	551,8	MHz		
Passband	PB	17.2	MHz		15,0 MHz
Pass band ripple	p-p	0,4	dB	max.	1,0 dB
Relative attenuation	a_{rel}				
f_N ... $f_N \pm 7,5$ MHz		0,4	dB	max.	2,0 dB
f_N ... $f_N \pm 8,0$ MHz		1	dB	max.	3,0 dB
$f_N - 100,0$ MHz ... $f_N - 17,0$ MHz		50	dB	min.	40,0 dB
$f_N + 17,0$ MHz ... $f_N + 100,0$ MHz		50	dB	min.	40,0 dB
Group delay ripple within PB	p-p	10	ns	max.	80 ns
VSWR within PB		1.4:1		max.	2:1
Operating temperature range	OTR	-			- 10 °C ... + 75 °C
Storage temperature range		-			- 40 °C ... + 85 °C
Temperature coefficient of frequency	TC_f **	-18	ppm/K		-

*) The terminating impedances depend on parasitics and q-values of matching elements and the board used, and are to be understood as reference values only. Should there be additional questions do not hesitate to ask for an application note or contact our design team.

**) $\Delta f(\text{Hz}) = TC_f(\text{ppm/K}) \times (T - T_0) \times f_{T0}(\text{MHz})$

Generated:**Checked / Approved:**

Tele Filter GmbH
Potsdamer Straße 18
D 14 513 TELTOW / Germany
Tel: (+49) 3328 4784-0 / Fax: (+49) 3328 4784-30
E-Mail: tft@telefilter.com

VI TELEFILTER reserves the right to make changes to the product(s) and/or information contained herein without notice. No liability is assumed as a result of their use or application. No rights under any patent accompany the sale of any such product(s) or information.

Filter characteristic

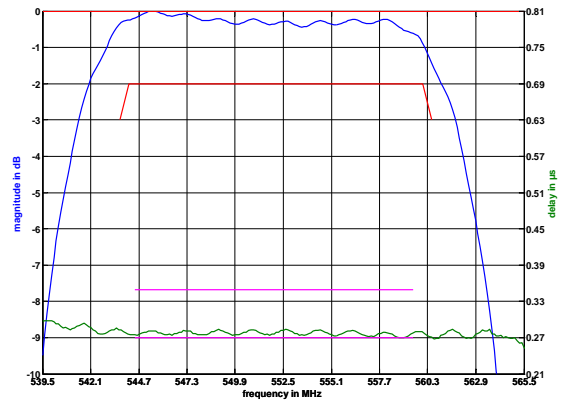
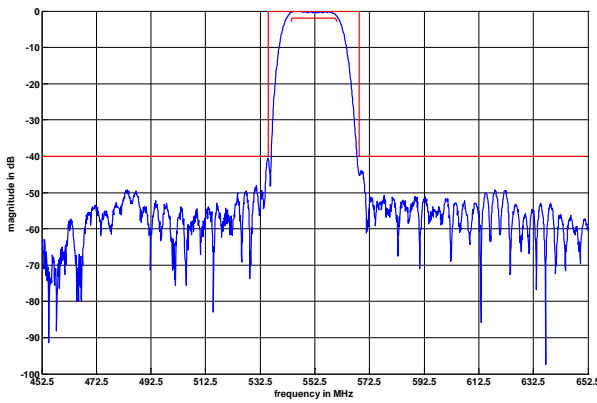

Construction and pin connection

(All dimensions in mm)

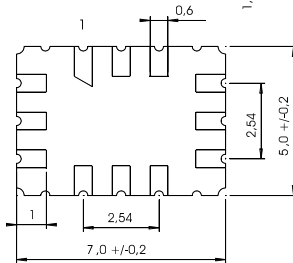
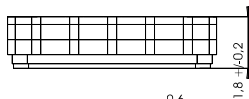
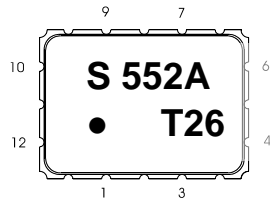

- 1 Ground
- 2 Ground
- 3 Ground
- 4 Output
- 5 Ground
- 6 Output RF Return
- 7 Ground
- 8 Ground
- 9 Ground
- 10 Input
- 11 Ground
- 12 Input RF Return

Date code: Year + week
 S 2004
 T 2005
 U 2006
 ...

50 Ohm Test circuit

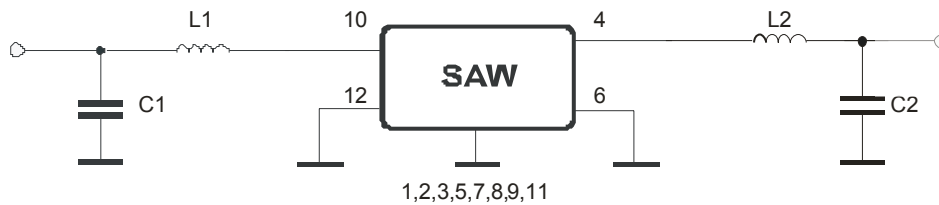

Tele Filter GmbH
 Potsdamer Straße 18
 D 14 513 TELTOW / Germany
 Tel: (+49) 3328 4784-0 / Fax: (+49) 3328 4784-30
 E-Mail: tft@telefilter.com

VI TELEFILTER reserves the right to make changes to the product(s) and/or information contained herein without notice. No liability is assumed as a result of their use or application. No rights under any patent accompany the sale of any such product(s) or information.

Stability characteristics

After the following tests the filter shall meet the whole specification:

1. Shock: 500g, 1 ms, half sine wave, 3 shocks each plane;
DIN IEC 68 T2 - 27
2. Vibration: 10 Hz to 500 Hz, 0,35 mm or 5 g respectively, 1 octave per min, 10 cycles per plan, 3 plans;
DIN IEC 68 T2 - 6
3. Change of temperature: -55 °C to 125°C / 30 min. each / 10 cycles
DIN IEC 68 part 2 – 14 Test N
4. Resistance to solder heat (reflow): reflow possible: twice max.;
for temperature conditions refer to the attached "Air reflow temperature conditions" on page 4;

Packing

Tape & Reel: IEC 286 – 3, with exception of value for N and minimum bending radius;
tape type II, embossed carrier tape with top cover tape on the upper side;

max. pieces of filters peer reel:	3000
reel of empty components at start:	min. 300 mm
reel of empty components at start including leader:	min. 500 mm
trailer:	min. 300 mm

Tape (all dimensions in mm)

- W : 16,00 ± 0,3
- Po : 4,00 ± 0,1
- Do : 1,50 +0,1/-0
- E : 1,75 ± 0,1
- F : 7,50 ± 0,1
- G(min) : 0,60
- P2 : 2,00 ± 0,1
- P1 : 8,00 ± 0,1
- D1(min) : 1,50
- Ao : 5,50 ± 0,1
- Bo : 7,50 ± 0,1
- Ct : 13,5 ± 0,1

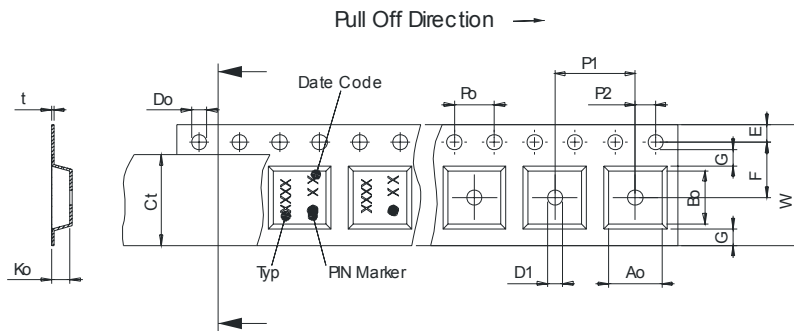

Reel (all dimensions in mm)

- A : 330
- W1 : 16,4 +2/-0
- W2(max) : 22,4
- N(min) : 50
- C : 13,0 +0,5/-0,2

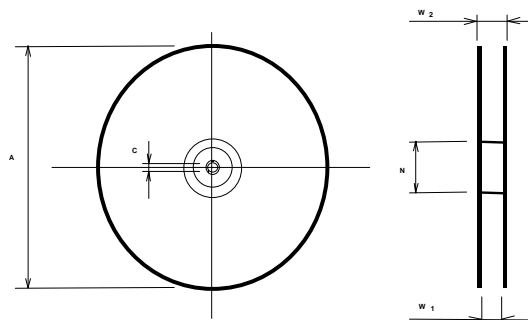

The minimum bending radius is 45 mm.

Tele Filter GmbH
Potsdamer Straße 18
D 14 513 TELTOW / Germany
Tel: (+49) 3328 4784-0 / Fax: (+49) 3328 4784-30
E-Mail: tft@telefilter.com

VI TELEFILTER reserves the right to make changes to the product(s) and/or information contained herein without notice. No liability is assumed as a result of their use or application. No rights under any patent accompany the sale of any such product(s) or information.

Air reflow temperature conditions

Conditions	Exposure
Average ramp-up rate (30°C to 217°C)	less than 3°C/second
> 100°C	between 300 and 600 seconds
> 150°C	between 240 and 500 seconds
> 217°C	between 30 and 150 seconds
Peak temperature	max. 260°C
Time within 5°C of actual peak temperature	between 10 and 30 seconds
Cool-down rate (Peak to 50°C)	less than 6°C/second
Time from 30°C to Peak temperature	no greater than 300 seconds

Chip-mount air reflow profile

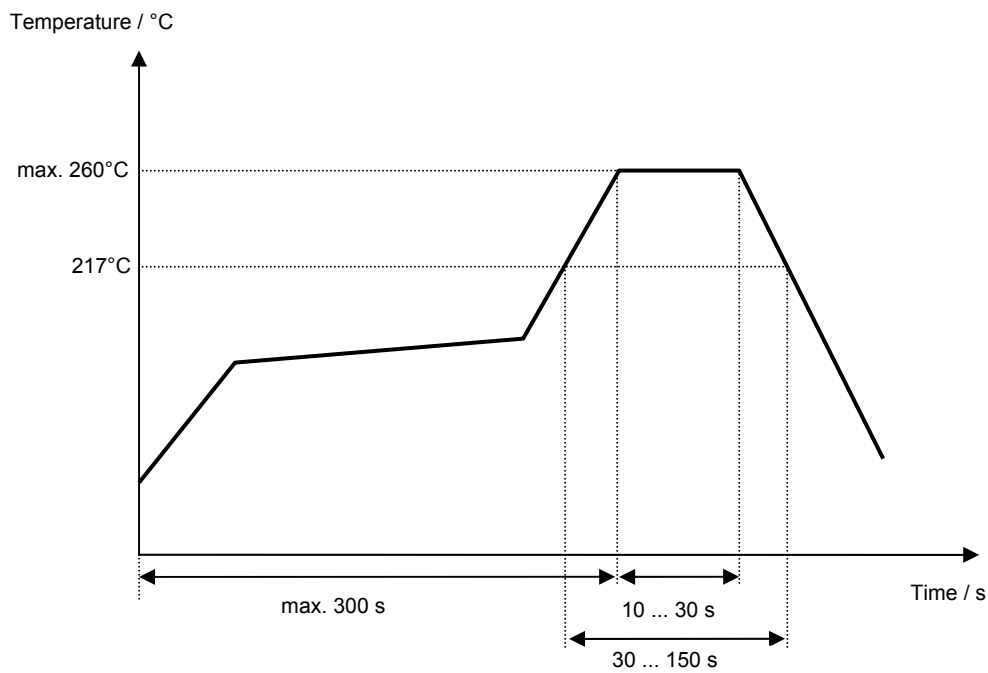

Tele Filter GmbH
 Potsdamer Straße 18
 D 14 513 TELTOW / Germany
 Tel: (+49) 3328 4784-0 / Fax: (+49) 3328 4784-30
 E-Mail: tft@telefilter.com

VI TELEFILTER reserves the right to make changes to the product(s) and/or information contained herein without notice. No liability is assumed as a result of their use or application. No rights under any patent accompany the sale of any such product(s) or information.

VI TELEFILTER**Filter specification****TFS 552A****5/5****History**

Version	Reason of Changes	Name	Date
1.0	Generation of development specification	Strehl	06.04.2005
1.1.	Changed construction	Strehl	27.06.2005
1.2.	created filter specification added terminating impedances added relative attenuation limit line at 2 dB added typical values added filter characteristic added test circuit	Chilla	28.06.2005

Tele Filter GmbH
Potsdamer Straße 18
D 14 513 TELTOW / Germany
Tel: (+49) 3328 4784-0 / Fax: (+49) 3328 4784-30
E-Mail: tft@telefilter.com

VI TELEFILTER reserves the right to make changes to the product(s) and/or information contained herein without notice. No liability is assumed as a result of their use or application. No rights under any patent accompany the sale of any such product(s) or information.