

**Vectron International****Filter specification****TFS 522****1/5****Measurement condition**

Ambient temperature:	23	°C
Input power level:	0	dBm
Terminating impedance:		
Input:	50	Ω
Output:	50	Ω

**Characteristics**

## Remark:

The maximum attenuation in the pass band is defined as the insertion loss  $a_e$ . The nominal frequency  $f_N$  is fixed at 522 MHz without any tolerance or limit. The values of absolute attenuation  $a_{abs}$  are guaranteed for the whole operating temperature range. The frequency shift of the filter in the operating temperature range is included in the production tolerance scheme.

<b>D a t a</b>			<b>typ. Value</b>		<b>tolerance / limit</b>	
<b>Insertion loss within PB</b>	$a_e$		2,2	dB	max.	3,0 dB
<b>Nominal frequency</b>	$f_N$		-			522 MHz
<b>Passband</b>	PB					24 MHz
<b>Absolute attenuation</b>	$a_{abs}$					
$f_N \pm 80$ MHz ... $f_N \pm 149$ MHz			48	dB	min.	33,5 dB
$f_N + 149$ MHz ... $f_N + 300$ MHz			49	dB	min.	45,0 dB
1 MHz ... 200 MHz			57	dB	min.	50,0 dB
200 MHz ... $f_N - 149$ MHz			60	dB	min.	55,0 dB
<b>Group delay ripple within PB</b>	p-p		10	ns	max.	0,2 μs
<b>IIP3</b>	*		-		min.	36 dBm
<b>Input power level</b>			-		max.	3 dBm
<b>Operating temperature range</b>	OTR		-			- 10 °C ... + 75 °C
<b>Storage temperature range</b>			-			- 40 °C ... + 85 °C
<b>Temperature coefficient of frequency</b>	$TC_f$ **		-76	ppm/K		-

\*)  $f_{in1} = f_C - 14$  MHz;  $f_{in2} = f_C - 14,4$  MHz;  $P_{in} = 0$  dBm;  $f_{measurement1} = f_C - 13,6$  MHz;  $f_{measurement2} = f_C - 14,8$  MHz. The centre frequency  $f_C$  is the arithmetic mean value of the upper and lower frequencies at the 3 dB filter attenuation level relative to the insertion loss  $a_e$ .

\*\*\*)  $\Delta f(\text{Hz}) = TC_f(\text{ppm/K}) \times (T - T_0) \times f_{T0}(\text{MHz})$

**Generated:****Checked / Approved:**

**Vectron International GmbH**  
**Potsdamer Straße 18**  
**D 14 513 TELTOW / Germany**  
**Tel: (+49) 3328 4784-0 / Fax: (+49) 3328 4784-30**  
**E-Mail: [tft@vectron.com](mailto:tft@vectron.com)**

Vectron International GmbH reserves the right to make changes to the product(s) and/or information contained herein without notice. No liability is assumed as a result of their use or application. No rights under any patent accompany the sale of any such product(s) or information.

**Filter characteristic**

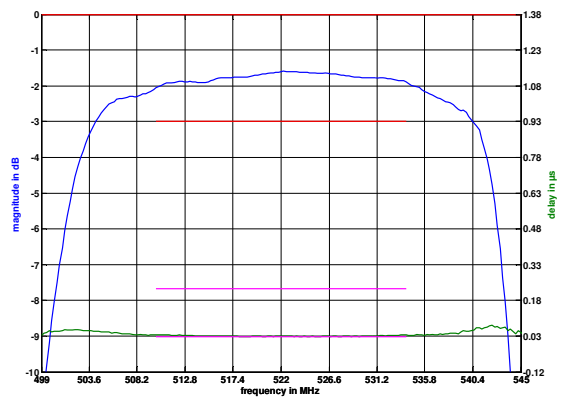
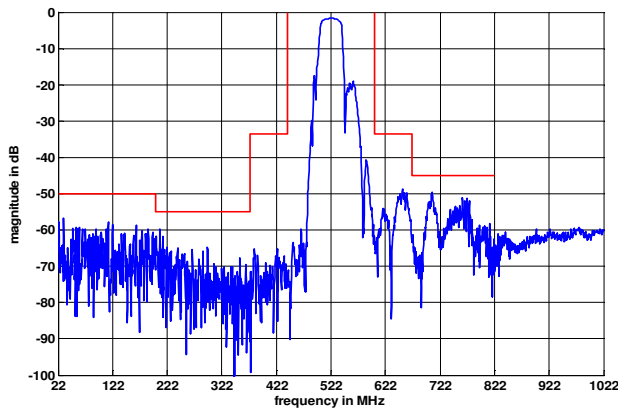

**Construction and pin connection**

(All dimensions in mm)

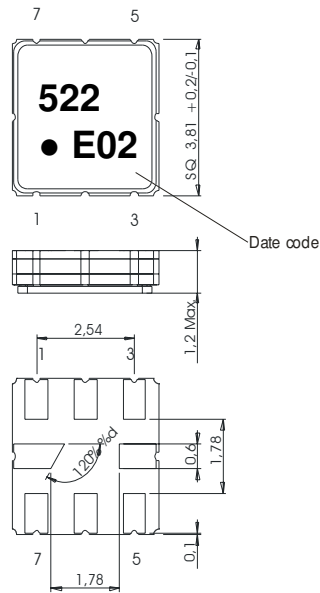

1	Ground
2	Input
3	Ground
4	Ground
5	Ground
6	Output
7	Ground
8	Ground

Date code: Year + week

E	2014
F	2015
G	2016
...	

**50 Ω Test circuit**

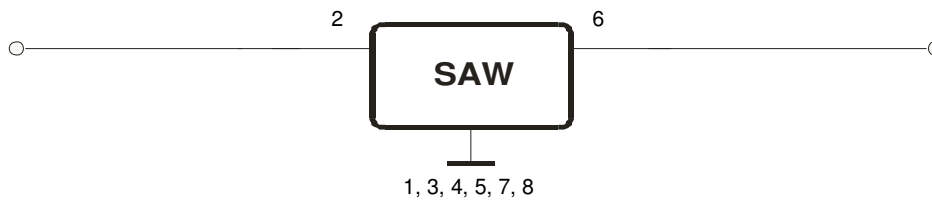

**Vectron International GmbH**  
 Potsdamer Straße 18  
 D 14 513 TELTOW / Germany  
 Tel: (+49) 3328 4784-0 / Fax: (+49) 3328 4784-30  
 E-Mail: [tft@vectron.com](mailto:tft@vectron.com)

Vectron International GmbH reserves the right to make changes to the product(s) and/or information contained herein without notice. No liability is assumed as a result of their use or application. No rights under any patent accompany the sale of any such product(s) or information.

**Stability characteristics, reliability**

After the following tests the filter shall meet the whole specification:

1. Shock: 500g, 1 ms, half sine wave, 3 shocks each plane;  
DIN IEC 68 T2 - 27
2. Vibration: 10 Hz to 500 Hz, 0.35 mm or g respectively, 1 octave per min, 10 cycles per plane, 3 planes; DIN IEC 68 T2 - 6
3. Change of temperature: -55 °C to 125°C / 15 min. each / 100 cycles  
DIN IEC 68 part 2 – 14 Test N
4. Resistance to solder heat (reflow): reflow possible: three times max.;  
for temperature conditions, see page 4: "Air reflow temperature conditions"

This filter is RoHS compliant (2011/65/EU)

**Packing**

Tape & Reel: IEC 286 – 3, with exception of value for N and minimum bending radius;  
tape type II, embossed carrier tape with top cover tape on the upper side;

max. pieces of filters per reel:	3000
reel of empty components at start:	min. 300 mm
reel of empty components at start including leader:	min. 500 mm
trailer:	min. 300 mm

**Tape (all dimensions in mm)**

- W : 12,00 ± 0,3
- Po : 4,00 ± 0,1
- Do : 1,50 +0,1/-0
- E : 1,75 ± 0,1
- F : 5,50 ± 0,05
- G(min) : 0,75
- P2 : 2,00 ± 0,05
- P1 : 8,00 ± 0,1
- D1(min) : 1,50
- Ao : 4,30 ± 0,1
- Bo : 4,30 ± 0,1
- Ct : 9,5 ± 0,1

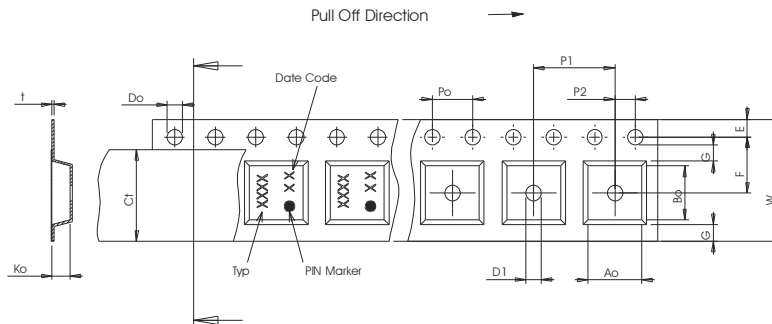

**Reel (all dimensions in mm)**

- A : 330
- W1 : 12,4 +2/-0
- W2(max) : 18,4
- N(min) : 50
- C : 13,0 +0,5/-0,2

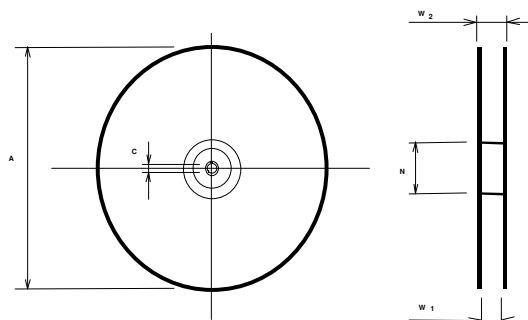

The minimum bending radius is 45 mm.

**Vectron International GmbH**  
**Potsdamer Straße 18**  
**D 14 513 TELTOW / Germany**  
**Tel: (+49) 3328 4784-0 / Fax: (+49) 3328 4784-30**  
**E-Mail: [tft@vectron.com](mailto:tft@vectron.com)**

Vectron International GmbH reserves the right to make changes to the product(s) and/or information contained herein without notice. No liability is assumed as a result of their use or application. No rights under any patent accompany the sale of any such product(s) or information.

**Air reflow temperature conditions**

<b>Conditions</b>	<b>Exposure</b>
Average ramp-up rate (30°C to 217°C)	less than 3°C/second
> 100°C	between 300 and 600 seconds
> 150°C	between 240 and 500 seconds
> 217°C	between 30 and 150 seconds
Peak temperature	max. 260°C
Time within 5°C of actual peak temperature	between 10 and 30 seconds
Cool-down rate (Peak to 50°C)	less than 6°C/second
Time from 30°C to Peak temperature	no greater than 300 seconds

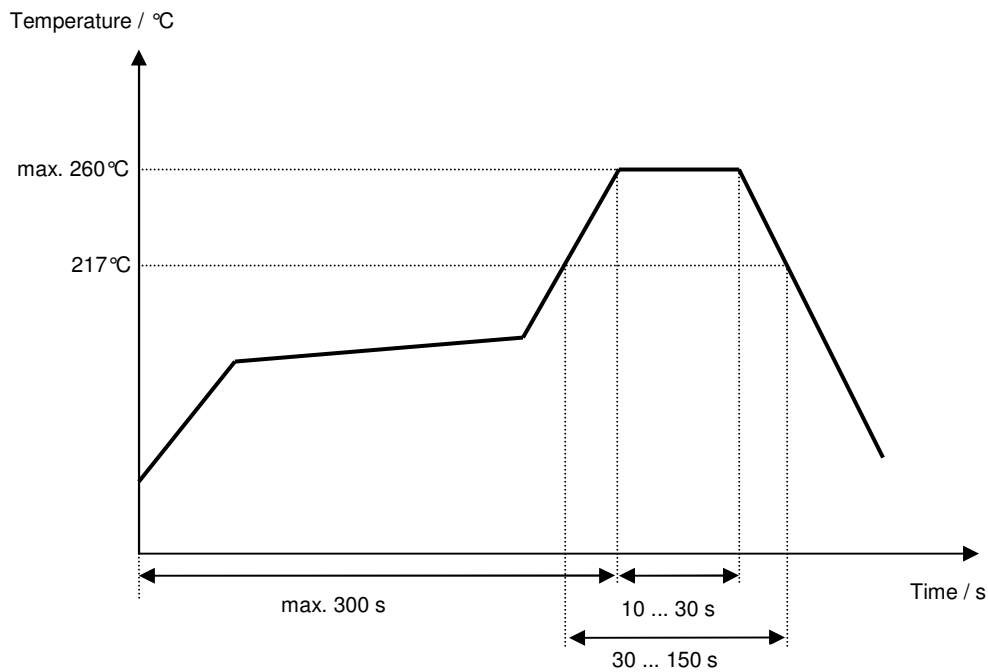
**Chip-mount air reflow profile**

**Vectron International GmbH**  
**Potsdamer Straße 18**  
**D 14 513 TELTOW / Germany**  
**Tel: (+49) 3328 4784-0 / Fax: (+49) 3328 4784-30**  
**E-Mail: [tft@vectron.com](mailto:tft@vectron.com)**

Vectron International GmbH reserves the right to make changes to the product(s) and/or information contained herein without notice. No liability is assumed as a result of their use or application. No rights under any patent accompany the sale of any such product(s) or information.

**History**

<b>Version</b>	<b>Reason of Changes</b>	<b>Name</b>	<b>Date</b>
1.0	Generation of development specification	Springfeldt	14.04.2004
1.1	Change of absolute attenuation $f_N + 149 \dots 300\text{MHz}$ change insertion loss	Strehl	20.01.2005
1.2	Change stability characteristics add typical values and filter characteristic generation of filter specification	Strehl	09.05.2005
1.3	Add IIP3 and change stability characteristics	Strehl	12.07.2006
1.4	maximum input power updated	Kortenbeutel	07.01.2014