

VI TELEFILTER

Filter Specification

TFS 246 H4

1/5

Measurement condition

Ambient temperature: 23 °C
 Input power level: 0 dBm
 Terminating impedances *)
 Input: 490 Ω || -2.62 pF
 Output: 490 Ω || -2.62 pF
 External coil: 270 nH

Characteristics

Remark:

Reference level for the relative attenuation a_{rel} of the TFS246H4 is the minimum of the pass band attenuation a_{min} . The minimum of the pass band attenuation a_{min} is defined as the insertion loss a_e . The centre frequency f_c is the arithmetic mean value of the upper and lower frequencies at the 3 dB filter attenuation level relative to the insertion loss a_e . The nominal frequency f_N is fixed at 246 MHz without any tolerance. The given values for the relative attenuation a_{rel} and for the group delay ripple have to be reached at the frequencies given below even if the centre frequency f_c is shifted due to the temperature coefficient of frequency TC_f in the operating temperature range and due to a production tolerance for the centre frequency f_c .

D a t a		typ. value	tolerance / limit
Insertion loss (Reference level)	$a_e = a_{min}$	2,5 dB	max 5 dB
Nominal frequency	f_N	-	246,000 MHz
Pass band ripple $f_N - 85$ kHz ... $f_N + 93$ kHz		0,5 dB	max 1,5 dB
Relative attenuation	a_{rel}		
f_N	$f_N \pm 120$ kHz	1,5 dB	max 3 dB
$f_N \pm 330$ kHz ... $f_N \pm 400$ kHz	$f_N \pm 400$ kHz	22 dB	min 18 dB
$f_N \pm 400$ kHz ... $f_N \pm 600$ kHz	$f_N \pm 600$ kHz	33 dB	min 25 dB
$f_N \pm 600$ kHz ... $f_N \pm 800$ MHz	$f_N \pm 800$ MHz	41 dB	min 40 dB
$f_N \pm 800$ kHz ... $f_N \pm 1,6$ MHz	$f_N \pm 1,6$ MHz	47...55 dB	min 45 dB
$f_N \pm 1,6$ MHz ... $f_N \pm 3,0$ MHz	$f_N \pm 3,0$ MHz	52...55 dB	min 45 dB
$f_N \pm 3,0$ MHz ... $f_N \pm 20$ MHz	$f_N \pm 20$ MHz	54 dB	min 46 dB
$f_N \pm 20$ MHz ... $f_N \pm 100$ MHz	$f_N \pm 100$ MHz	55...70 dB	min 45 dB
Group delay distortion	GDD		
$f_N \pm 50$ kHz		0,5 µs	max 1,2 µs
$f_N \pm 70$ kHz		0,8 µs	max 1,5 µs
$f_N \pm 100$ kHz		1,2 µs	max 2,5 µs
Operating temperature range		-	- 25 °C ... + 85 °C
Storage temperature range		-	- 30 °C ... + 85 °C
Temperature coefficient of frequency TC_f **)		- 0,036 ppm/K ²	-
Frequency inversion temperature T_0		+ 25 °C	-

*) The terminating impedances depend on parasitics and q-values of matching elements and the board used, and are to be understood as reference values only. Should there be additional questions do not hesitate to ask for an application note or contact our design team.

**) $\Delta f(\text{Hz}) = TC_f(\text{ppm}/K^2) \times (T-T_0)^2 \times f_{T0}(\text{MHz})$

Generated:

Checked / approved:

VI TELEFILTER
 Potsdamer Straße 18
 D 14 513 TELTOW / Germany
 Tel: (+49) 3328 4784-0 / Fax: (+49) 3328 4784-30
 E-Mail: tft@telefilter.com

Vectron International, Inc.
 267 Lowell Road
 Hudson, NH 03051 / USA
 Tel: (603) 598-0070 Fax: (603) 598-0075
 E-Mail: vti@vtinh.com

VI TELEFILTER reserves the right to make changes to the product(s) and/or information contained herein without notice. No liability is assumed as a result of their use or application. No rights under any patent accompany the sale of any such product(s) or information.

VI TELEFILTER

Filter Specification

TFS 246 H4

2/5

Construction and pin configuration

(All dimensions in mm)

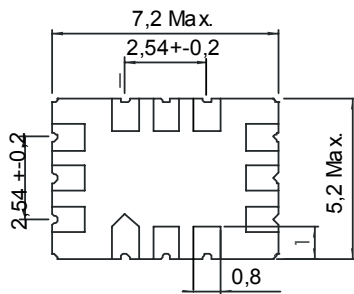
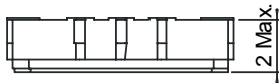
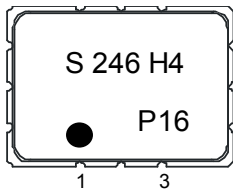

Datecode	Year + week
M	2000
N	2001
P	2002
...	

1	Input
7	Output
3,4	External coil
2,5,6,8,9,10,11,12	Ground

50 Ohm Test circuit 1

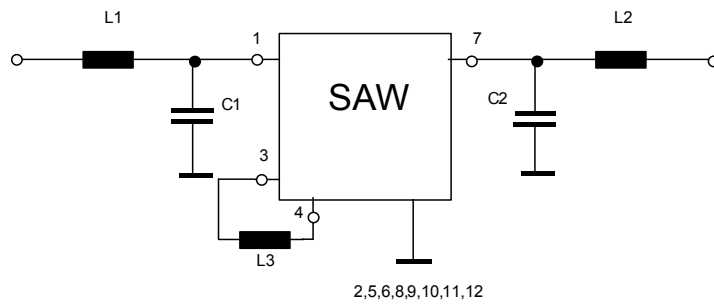

50 Ohm Test circuit 2

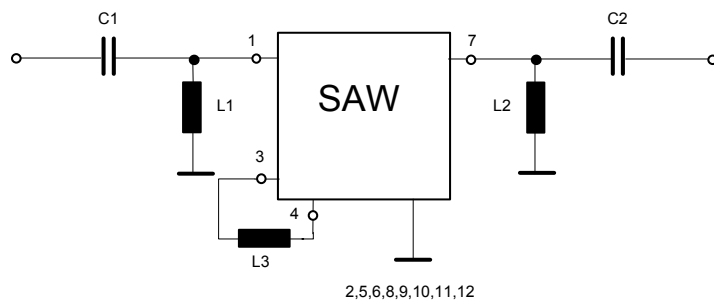

VI TELEFILTER
 Potsdamer Straße 18
 D 14 513 TELTOW / Germany
 Tel: (+49) 3328 4784-0 / Fax: (+49) 3328 4784-30
 E-Mail: tft@telefilter.com

Vectron International, Inc.
 267 Lowell Road
 Hudson, NH 03051 / USA
 Tel: (603) 598-0070 Fax: (603) 598-0075
 E-Mail: vti@vtinh.com

VI TELEFILTER reserves the right to make changes to the product(s) and/or information contained herein without notice. No liability is assumed as a result of their use or application. No rights under any patent accompany the sale of any such product(s) or information.

VI TELEFILTER

Filter Specification

TFS 246 H4

Stability characteristics

After the following tests the filter shall meet the whole specification:

1. Shock: 500g, 18 ms, half sine wave, 3 shocks each plane;
DIN IEC 68 T2 - 27
2. Vibration: 10 Hz to 500 Hz, 0,35 mm or 5g respectively, 1 octave per min, 10 cycles per plan, 3 plans;
DIN IEC 68 T2 - 6
3. Change of temperature: -55 °C to 125°C / 30 min. each / 10 cycles
DIN IEC 68 part 2 – 14 Test N
4. Resistance to solder heat (reflow): reflow possible: twice max.;
for temperature conditions, please refer to the attached "Air reflow temperature conditions" on page 4;

Packing

Tape & Reel: IEC 286 - 3, with exception of value for N and minimum bending radius;
tape type II, embossed carrier tape with top cover tape on the upper side;

max. pieces of filters per reel:	3000
Reel of empty components at start:	min 300 mm
Reel of empty components at start including leader:	min 500 mm
Trailer	min 300 mm

Tape (all dimensions in mm)

- W : 16 ± 0,3
- Po : 4 ± 0,1
- Do : 1,5 + 0,1
- E : 1,75 ± 0,1
- F : 7,5 ± 0,1
- G (min) : 0,6
- P2 : 2 ± 0,1
- P1 : 8 ± 0,1
- D1(min) : 1,5
- Ao : 5,5 ± 0,1
- Bo : 7,5 ± 0,1

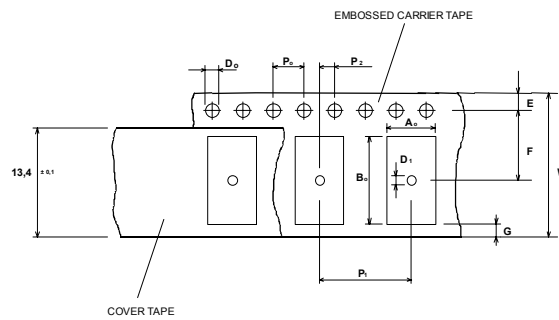

Reel (all dimensions in mm):

- A : 330
- W1 : 16,4 +2
- W2 (max) : 22,4
- N (min) : 50
- C : 13 + 0,5 / - 0,2

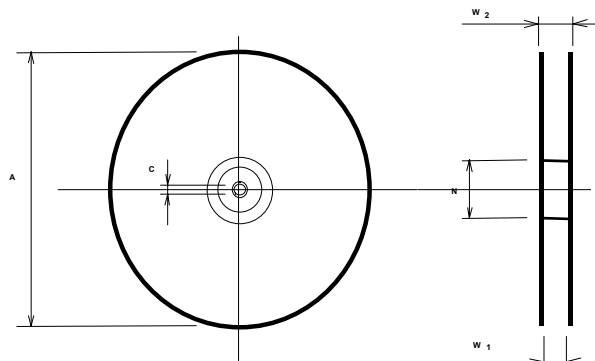

The minimum bending radius is 45 mm. The mounting surface of the filters faces the bottom side of the embossed carrier tape. Markings on the filters can be read if the upper side of the carrier tape is regarded with the sprocket holes on its right.

VI TELEFILTER
Potsdamer Straße 18
D 14 513 TELTOW / Germany
Tel: (+49) 3328 4784-0 / Fax: (+49) 3328 4784-30
E-Mail: tft@telefilter.com

Vectron International, Inc.
267 Lowell Road
Hudson, NH 03051 / USA
Tel: (603) 598-0070 Fax: (603) 598-0075
E-Mail: vti@vtinh.com

VI TELEFILTER reserves the right to make changes to the product(s) and/or information contained herein without notice. No liability is assumed as a result of their use or application. No rights under any patent accompany the sale of any such product(s) or information.

Air reflow temperature conditions

1st and 2nd air reflow profile

Name:	pre-heating periods	main-heating periods	peak temperature
Temperature:	150 °C - 170 °C	over 200 °C	255 °C ± 5 °C
Time:	60 sec. - 90 sec.	20 sec. - 25 sec.	

Chip-mount air reflow profile

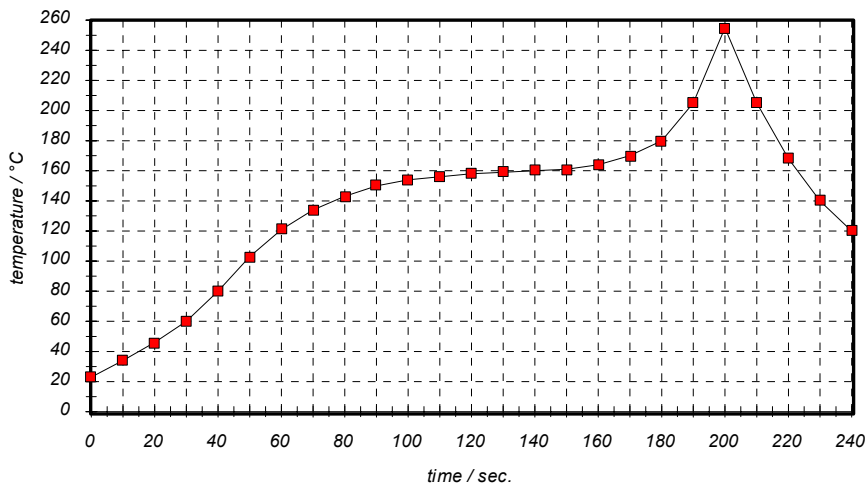

Table for temperature vs. time during the air reflow process

Tolerance of temperatures: ± 5 °C

time / sec.	temperature / °C	time / sec.	temperature / °C
0	23	140	160
10	34	150	161
20	46	160	164
30	60	170	170
40	80	180	180
50	103	190	205
60	121	195	230
70	134	200	255
80	143	205	230
90	150	210	205
100	154	215	180
110	156	220	165
120	158	230	140
130	159	240	120

VI TELEFILTER
 Potsdamer Straße 18
 D 14 513 TELTOW / Germany
 Tel: (+49) 3328 4784-0 / Fax: (+49) 3328 4784-30
 E-Mail: tft@telefilter.com

Vectron International, Inc.
 267 Lowell Road
 Hudson, NH 03051 / USA
 Tel: (603) 598-0070 Fax: (603) 598-0075
 E-Mail: vti@vtinh.com

VI TELEFILTER reserves the right to make changes to the product(s) and/or information contained herein without notice. No liability is assumed as a result of their use or application. No rights under any patent accompany the sale of any such product(s) or information.

VI TELEFILTER**Filter Specification****TFS 246 H4****5/5****History**

Version	Reason of Changes	Name	Date
1.0	Generate specification according to customer's requirements	Dr. Wall	07.02.2002
1.1	Add and correct typical data. Correct value for coupling coil.	Dr. Wall	27.03.2002
1.2	Change operating temperature range from -20°C ... 85°C to -25°C ... 85°C	Dr. Wall	19.04.2002
1.3	Correct typo for first selection value (from 8 to 18 dB)	Dr. Wall	16.05.2002

VI TELEFILTER
Potsdamer Straße 18
D 14 513 TELTOW / Germany
Tel: (+49) 3328 4784-0 / Fax: (+49) 3328 4784-30
E-Mail: tft@telefilter.com

Vectron International, Inc.
267 Lowell Road
Hudson, NH 03051 / USA
Tel: (603) 598-0070 Fax: (603) 598-0075
E-Mail: vti@vtinh.com

VI TELEFILTER reserves the right to make changes to the product(s) and/or information contained herein without notice. No liability is assumed as a result of their use or application. No rights under any patent accompany the sale of any such product(s) or information.