

High Efficiency / High Uniformity
Color-mixing Lens
- Narrow Flood Beam



Superior color uniformity
for white and multi-color emitters

LLNF-3T08-H

This unique lens enables the design and implementation of new high quality, high brightness products with precision optics delivering a high quality smooth beam pattern and superior color-mixing quality. This narrow flood beam lens combined with LedEngin 40W White LEDs provides a well-controlled, smooth light gradient for illumination applications. The high uniformity, high efficiency color-mixing design delivers exceptional color quality for 40W multi-color RGB emitters.

Key Features

- Smooth light gradient eliminates hot spots and rings for superior illumination
- Superior color uniformity for multi-color RGB emitters over the full color spectrum
- High optical efficiency
- Designed specifically for 40W white and multi-color RGB emitter
- Optical grade PMMA lens material allows use of high current and temperature conditions
- Lens holder aligns with LedEngin MCPCB option for easy installation and assembly
- Lens holder fastens easily to PCB with appropriate adhesive, e.g. epoxy or polyurethane based
- Patent pending

Optical Specifications – Typical Values

Parameter	Value
Viewing Angle (FWHM)	24°
Optical Efficiency	80%
Color Mixing	Superior

Typical Relative Intensity over Angle

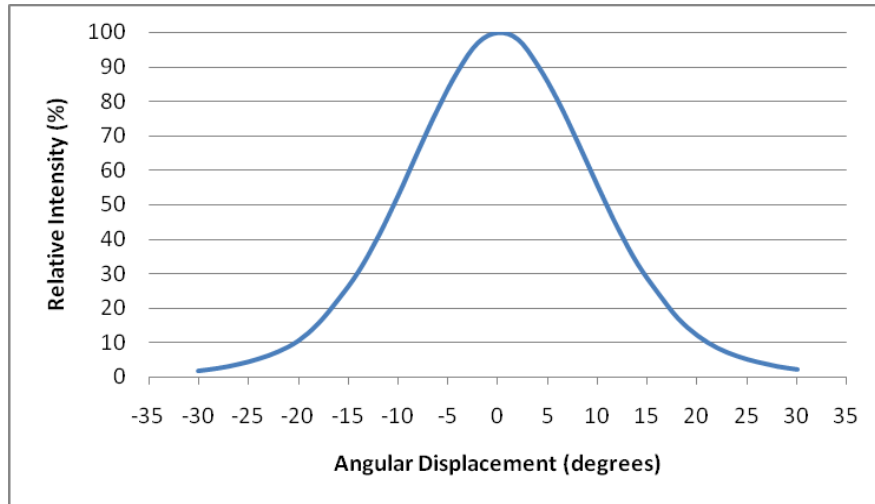

Mechanical Specifications (Includes Lens and Holder)

Parameter	Value
Height from Seating Plane	25.0mm
Maximum Width	47.50mm
Operating Temperature Range	-40°C ~ +110°C
Acceptable bonding materials*	Epoxy or polyurethane-based adhesives

*Note: do not use a cyanoacrylate (superglue) adhesive!

Outline Dimensions

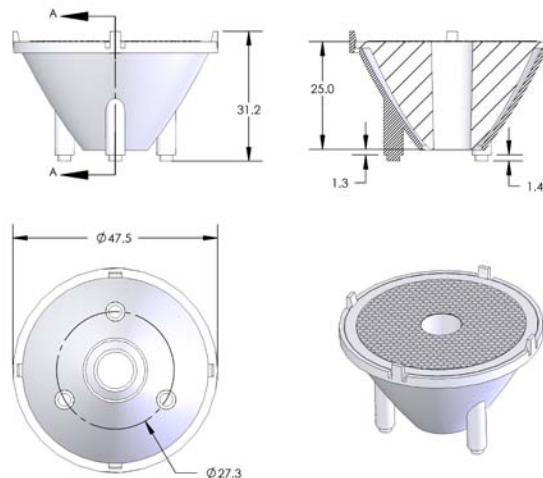

Contact

LedEngin, Inc.
3350 Scott Boulevard, Building #9
Santa Clara, CA 95054 USA

Information

Tel: +1 (408) 492-0620
E-mail: Sales@ledengin.com
Website: www.ledengin.com