

SPECIFICATION
 Contacts Current Rating:0.5 Amp
 Dielectric Withstanding Voltage:500V AC
 Contact Resistance:35 Milliohms Max.
 Insulation Resistance:>500 Megaohms Min.
 Operation Temperature:-55°C~+85°C
 Housing:PBT(UL94V-0),Black
 Contact:Phosphor Bronze
 Selective Gold Plated 5u" Over Nickel
 Front Shell:Steel,Nickel Plated Over Copper
 Hood:ABS(UL94V-0),Beige
 Latch Cover:ABS(UL94V-0),Beige
 Latch:Stainless Steel
 Inner Shell:Steel,Nickel Plated Over Copper
 RoHS Compliant

HPD 050 P S Q - H
 (1) (2) (3) (4) (5) (6)

- (1) HPD:1.27mm SCSI Pin Type
- (2) 050:No. Of Position
- (3) P:Male
- (4) S:Solder Wire
- (5) Q:Plastic Hood Beige Color Latch Type
- (6) H:RoHS Compliant

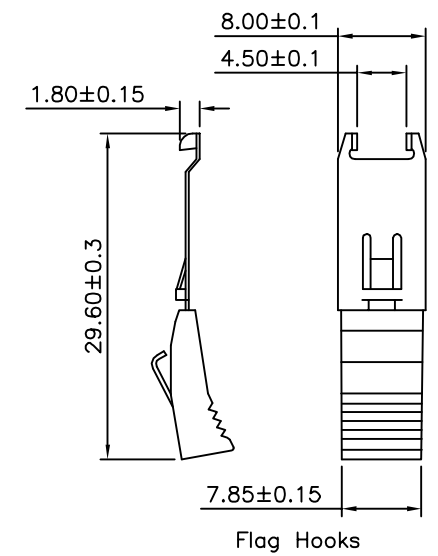
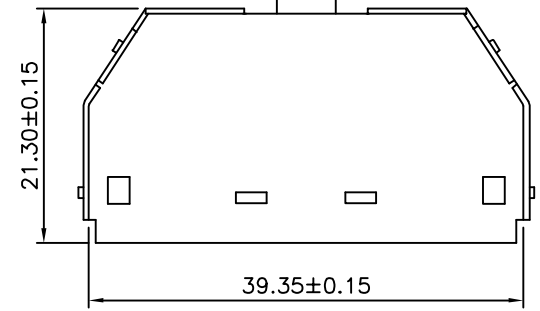
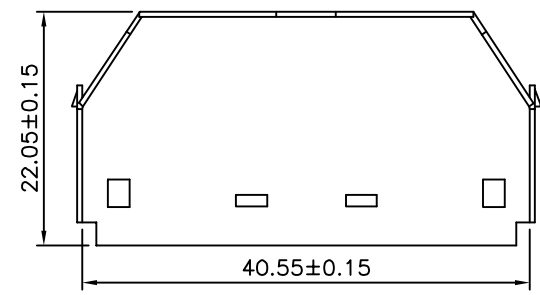
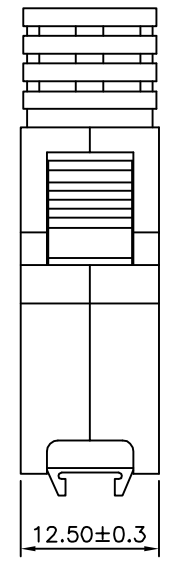
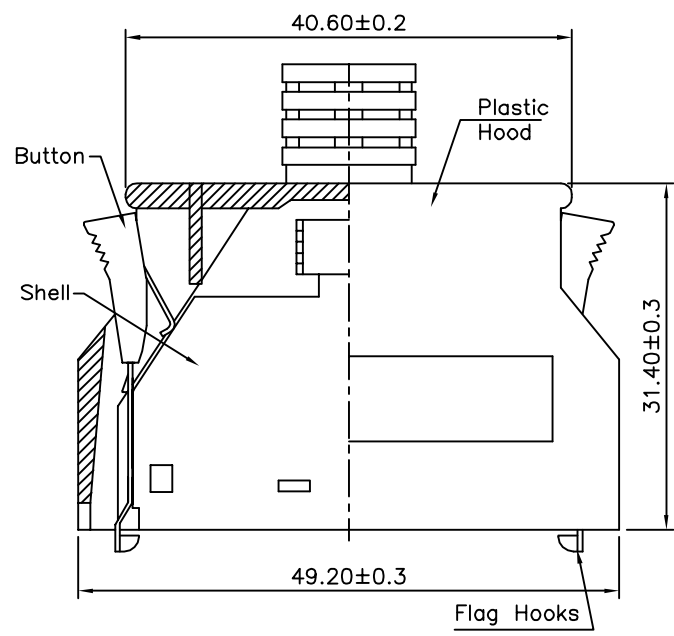
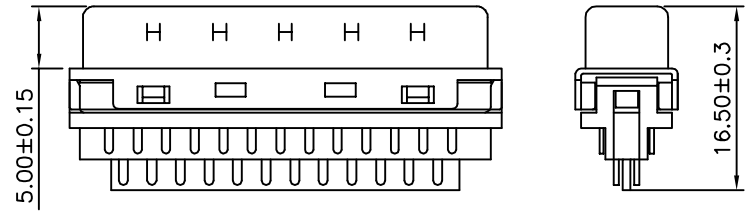
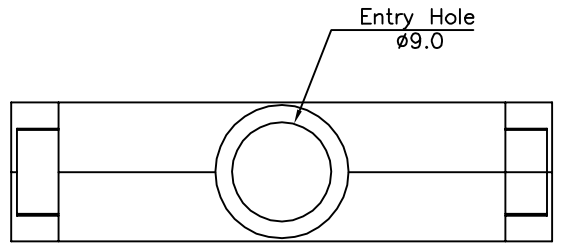
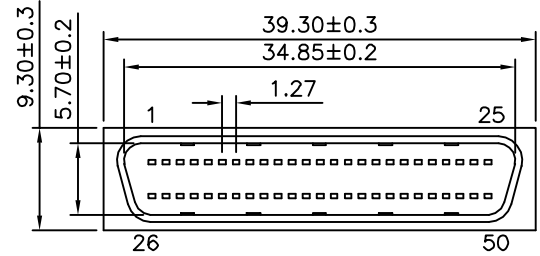

AUK A MEMBER OF AUK GROUP
太聯事業股份有限公司
AUK CONTRACTORS CO., LTD.

CATEGORY		APPROVED BY		UNLESS OTHERWISE SPECIFIED TOLERANCES ARE .X ±0.38 .XX ±0.25 ANG.
PART No. HPD050PSQ-H		EMILY		
DRAWING No. HPD050PSQ-H		CHECKED BY HZF		
SCALE		DRAWING BY HTP		
SCALE	NONE	REV.	A0	UNIT mm

NO.	REV.	REVISIONS	CHK	DATE
△ A0		NEW RELEASE	HZF	10/06/2011