

**SPECIFICATION**  
 Contacts Current Rating:0.5 Amp  
 Dielectric Withstanding Voltage:500V AC  
 Contact Resistance:35 Milliohms Max.  
 Insulation Resistance:>500 Megaohms Min.  
 Operation Temperature:-55°C~+85°C  
 Housing:PBT(UL94V-0),Black  
 Contact:Phosphor Bronze  
 Selective Gold Plated 5u" Over Nickel  
 Front Shell:Steel,Nickel Plated Over Copper  
 Hood:ABS(UL94V-0),Beige  
 Latch Cover:ABS(UL94V-0),Beige  
 Latch:Stainless Steel  
 Inner Shell:Steel,Nickel Plated Over Copper  
 RoHS Compliant

HPD 026 P S Q - H  
 (1) (2) (3) (4) (5) (6)

- (1) HPD:1.27mm SCSI Pin Type
- (2) 026:No. Of Position
- (3) P:Male
- (4) S:Solder Wire
- (5) Q:Plastic Hood Beige Color Latch Type
- (6) H:RoHS Compliant

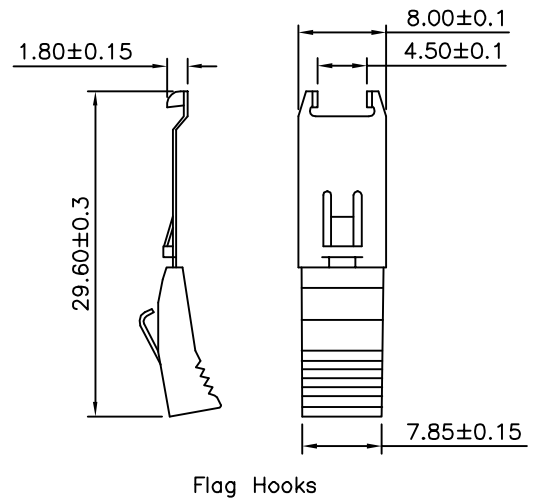
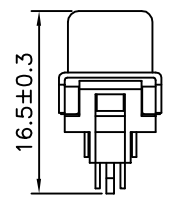
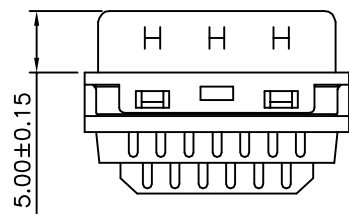
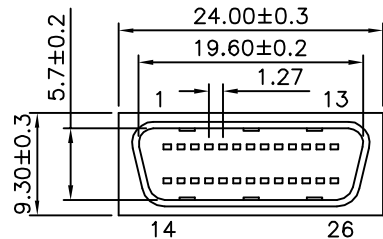
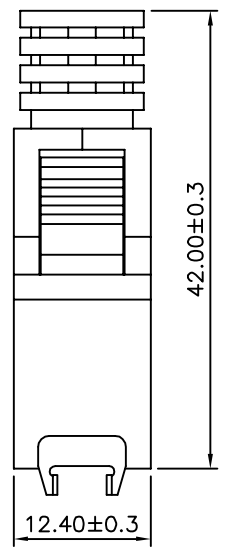
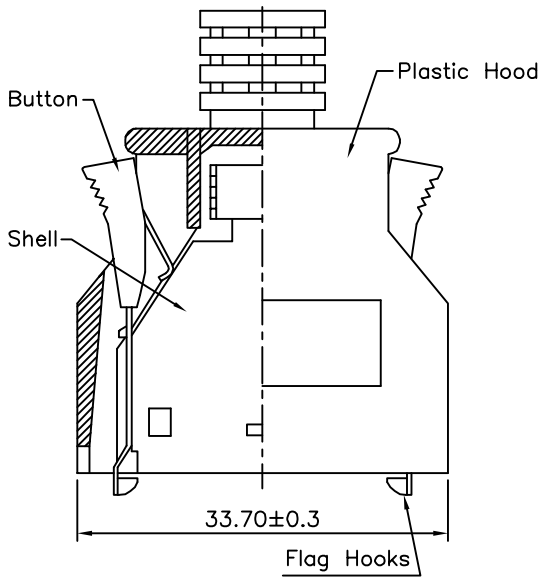
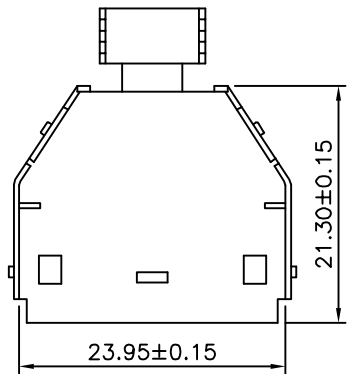
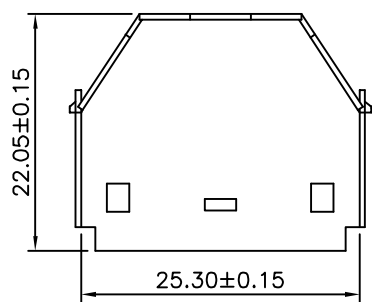
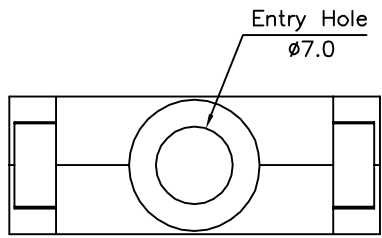

**AUK** A MEMBER OF AUK GROUP  
**太聯事業股份有限公司**  
**AUK CONTRACTORS CO., LTD.**

CATEGORY		APPROVED BY		UNLESS OTHERWISE SPECIFIED TOLERANCES ARE .X ±0.38 .XX ±0.25 ANG.
PART No. HPD026PSQ-H		EMILY		
DRAWING No. HPD026PSQ-H		CHECKED BY HZF		
SCALE NONE		DRAWING BY HTP		
REV.	A0	UNIT mm	NO. REV.	△ A0

NO. REV.	△ A0	NEW RELEASE	HZF	10/06/2011
NO. REV.	REVISIONS		CHK	DATE