

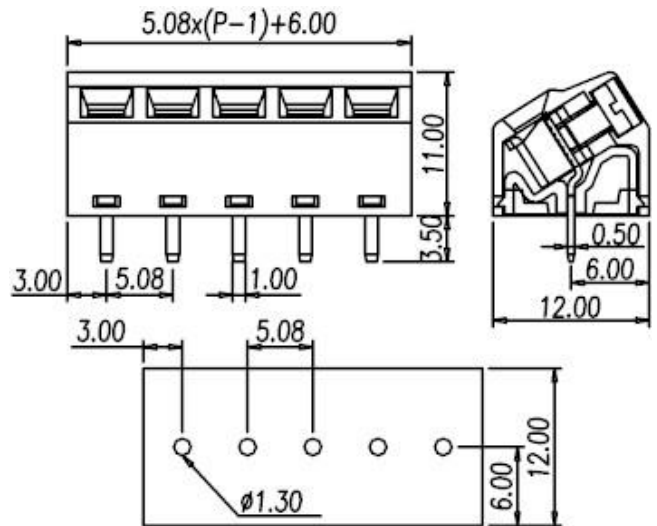



European P.C.B. type terminal blocks / EK series



ELK508A



Pitch: 5.08mm

Approval	  	
Technical Data	UL	IEC
Rated voltage	300V	250V
Rated current	13.5A	17.5A
Conductor cross-section, solid (AWG/ mm ²)	30~16 / 0.14~1.5	
Conductor cross-section, flexible (AWG/ mm ²)	30~16 / 0.14~1.5	
Rated surge voltage (UL/IEC/Max.)	1.6 / 2 / 3 KV	
Torque (N-m)	0.50	
Screw	M2.5	
Wire strip length	5~6mm	
Pole	Cat. No.	
02	ELK508A-02P	
:	:	
:	:	
24	ELK508A-24P	

TEL: +886-2-2908-0614

FAX: +886-2-2908-8549

E-mail: info@dinkle.com.tw