

**SPECIFICATION**

- 1. **General Characteristics**  
3.0mm Micro Fit 2XXX DIP 90° Male With Post Black
- 2. **Material&Finish**  
Insulator:PA66(UL94V-0),Black  
Contact:Brass,Tin Plated
- 3. **Electrical Characteristics**  
Current Rating:5A AC/DC  
Voltage Rating:250V AC/DC  
Withstanding Voltage:1500V AC/Minute  
Contact Resistance:10 Milliohms Max.  
Insulation Resistance:1000 Megaohms Min.
- 4. **Environmental Characteristics**  
Temperature Range:-25°C~+85°C
- 5. **RoHS Compliant**

MIF 2 X XX P RP - H  
(1) (2) (3) (4) (5) (6)

- (1) MIF:3.0mm Micro Fit
- (2) 2: Dual Row
- (3) XX: No. Of Position/Per Row
- (4) P: Male
- (5) RP: DIP Right Angle With Post
- (6) H: RoHS Compliant

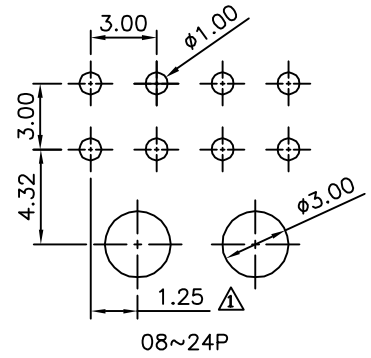
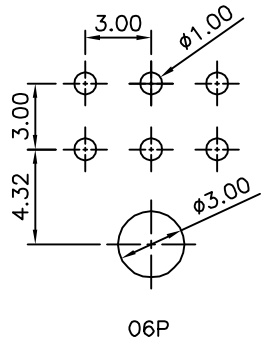
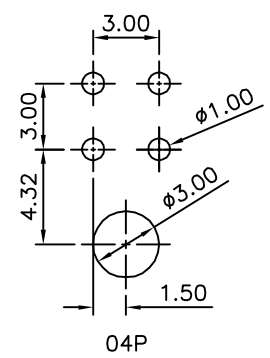
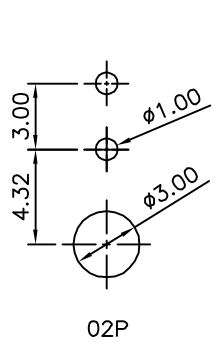
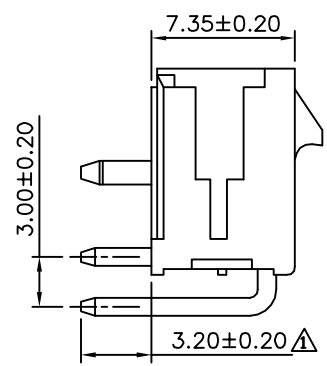
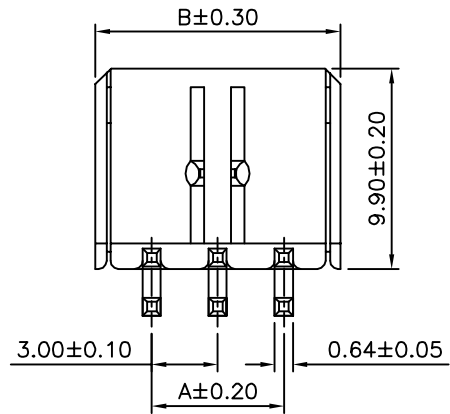
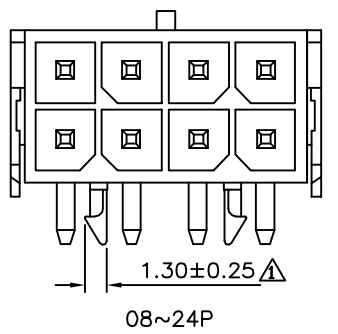
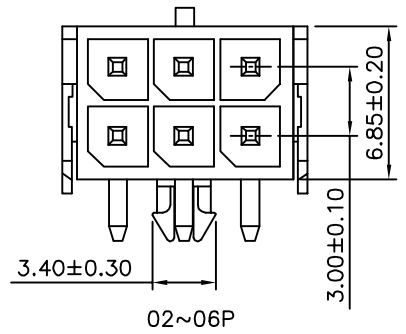

Recommended P.C.B. Layout

Pin	A	B
02	—	6.65
04	3.00	9.65
06	6.00	12.65
08	9.00	15.65
10	12.00	18.65
12	15.00	21.65
14	18.00	24.65
16	21.00	27.65
18	24.00	30.65
20	27.00	33.65
22	30.00	36.65
24	33.00	39.65

**AUK** A MEMBER OF AUK GROUP  
**太聯事業股份有限公司**  
**AUK CONTRACTORS CO., LTD.**

CATEGORY		APPROVED BY MEI		UNLESS OTHERWISE SPECIFIED TOLERANCES ARE X. ±0.30 .X ±0.25 .XX ±0.20 .XXX ±0.015
PART No. MIF2XXXPRP-H		CHECKED BY HZF		
DRAWING No. MIF2XXXPRP-H		DRAWING BY GAO		
SCALE	NONE	REV.	A1	
UNIT	mm			NO.REV.

NO.	REV.	REVISIONS	CHK	DATE
△A1		Modify Data	HZF	08/28/2013
△A0		NEW RELEASE	HZF	11/16/2011

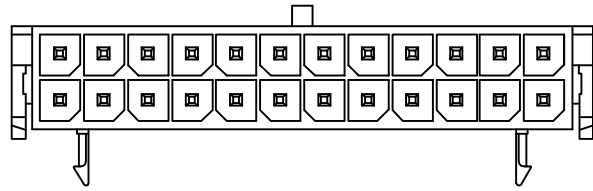

2X12P

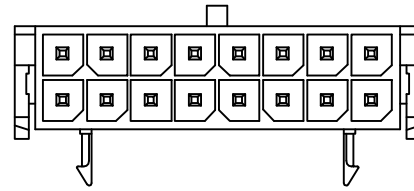

2X08P

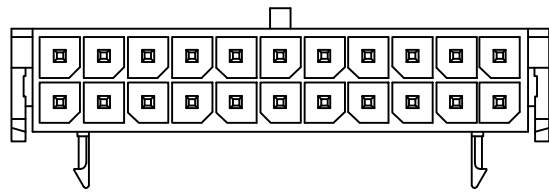

2X11P

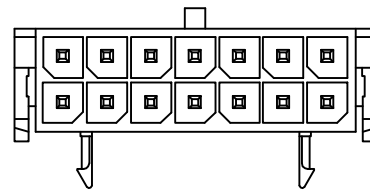

2X07P

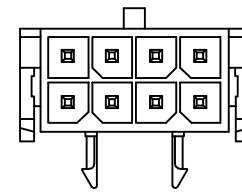

2X04P

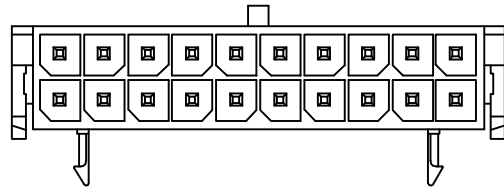

2X10P

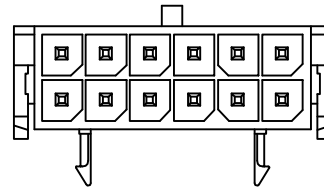

2X06P

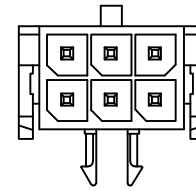

2X03P

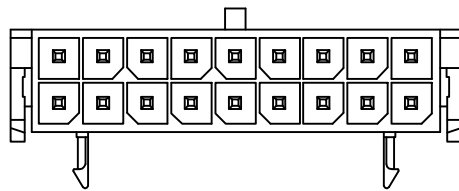

2X09P

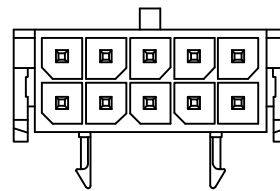

2X05P

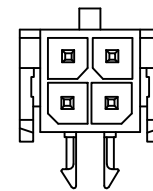

2X02P

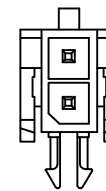

2X01P



A MEMBER OF AUK GROUP  
**太聯事業股份有限公司**  
**AUK CONTRACTORS CO., LTD.**

CATEGORY		APPROVED BY MEI	
PART No. MIF2XXXPRP-H		CHECKED BY HZF	
DRAWING No. MIF2XXXPRP-H		DRAWING BY GAO	
SCALE	NONE	REV.	A1

UNLESS OTHERWISE SPECIFIED TOLERANCES ARE  
 X. ±0.30  
 .X ±0.25  
 .XX ±0.20  
 .XXX ±0.015

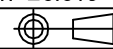

NO.	REV.	REVISIONS	CHK	DATE
△	A1	Modify Data	HZF	08/28/2013
△	A0	NEW RELEASE	HZF	11/16/2011