



*classic mono LCDs*

# SPECIFICATION

## GRAPHIC TYPE

### DOT MATRIX LCD MODULE



ITEM NUMBER:	FDCG12864M-FLYYBH-51XN
ESTABLISHED DATE:	1999.06
INITIAL ISSUED DATE:	2005.05
DATASHEET VERSION:	2008 VERSION

ISSUED BY:  CHECKED BY:  APPROVED BY: 

COPYRIGHT © 2000 ~ 2008 FORDATA ELECTRONIC CO., LTD. ALL RIGHTS RESERVED

 <b>FORDATA ELECTRONIC CO.,LTD</b> PROFESSIONAL LCD SUPPLIER FROM CHINA	<b>STANDARD DOC.</b>	<b>DATASHEET STATEMENT</b>
--	----------------------	----------------------------











- The following icons are absolutely designed by FORDATA independently in 2007-SEP. They are not in common use in the LCD industry yet but just used for marking out FORDATA products' characteristics quickly and simply without any special meaning. FORDATA reserves the composing right and copyright. No one else is allowed to adopt these icons without FORDATA's approval.
- The ISO9001 logo used in this document is authorized by SGS (www.sgs.com). FORDATA had already successfully passed the strict and professional ISO9001:2000 Quality Management System Certification and got the certificate (No.: CN07/00404)
- The technologies/techniques/crafts which denoted by the following icons are not exclusively owned by FORDATA, but also shared by FORDATA's LCD strategic cooperators, however all these technologies/techniques/crafts have been finally confirmed by FORDATA's professional engineers and QC department.
- As the difference in test standard and test conditions, also FORDATA's insufficient familiarity with the actual LCD using environment, all the referred information in this DATASHEET (including the icons) only have two functions:
  - providing quick reference when you are judging whether or not the product meets your requirements.
  - listing out definitely the tolerance.

**FORDATA declares seriously:** you should first test the corresponding sample(s) before signing the formal FORDATA SAMPLE APPROVAL document rather than consider this DATASHEET as the standard for judging whether or not the LCD meets your requirements. Once you instruct FORDATA to a mass-production without definite demand for providing sample before, FORDATA will disclaim all responsibility if the mass-production is proved not meeting with your requirements.
- The sequence of the icons is random and doesn't indicate the importance grade.
- Icons explanation

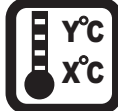

FORDATA's 2006 version logo. FORDATA is an integrated manufacturer of flat panel display (FPD). FORDATA supplies TN, HTN, STN, FSTN monochrome LCD panel; COB, COG, TAB LCD module; and all kinds of LED backlight.

*classic mono LEDs*

- |   |   |
|---|---|
|  <p><b>FAST RESPONSE TIME</b><br/>This icon on the cover indicates the product is with high response speed; Otherwise not.</p>                 |  <p><b>PROTECTION CIRCUIT</b><br/>This icon on the cover indicates the product is with protection circuit; Otherwise not.</p>  |
|  <p><b>HIGH CONTRAST</b><br/>This icon on the cover indicates the product is with high contrast; Otherwise not.</p>                            |  <p><b>LONG LIFE VERSION</b><br/>This icon on the cover indicates the product is long life version (over 9K hours guaranteed); Otherwise not.</p>  |
|  <p><b>WIDE VIEWING SCOPE</b><br/>This icon on the cover indicates the product is with wide viewing scope; Otherwise not.</p>                  |  <p><b>Anti UV VERSION</b><br/>This icon on the cover indicates the product is against UV line. Otherwise not.</p>   |
|  <p><b>RoHS COMPLIANCE</b><br/>This icon on the cover indicates the product meets ROHS requirements; Otherwise not.</p>                        |  <p><b>OPERATION TEMPERATURE RANGE</b><br/>This icon on the cover indicates the operating temperature range (X-Y).</p>   |
|  <p><b>3TIMES 100% QC EXAMINATION</b><br/>This icon on the cover indicates the product has passed FORDATA's thrice 100% QC. Otherwise not.</p> |  <p><b>TWICE SELECTION OF LED MATERIALS</b><br/>This icon on the cover indicates the LED had passed FORDATA's twice strict selection which promises the product's identical color and brightness; Otherwise not.</p> |
|  <p><b>Vlcm = 3.0V</b><br/>This icon on the cover indicates the product can work at 3.0V exactly; otherwise not.</p>                           |  <p><b>N SERIES TECHNOLOGY (2008 developed)</b><br/>FORDATA adopts new structure, new craft, new technology and new materials inside both LCD module and LCD panel to improve the "RainBow"</p>                      |

**BOOKBINDING AREA**



**FORDATA ELECTRONIC CO.,LTD**  
**PROFESSIONAL LCD SUPPLIER FROM CHINA**

**STANDARD  
 DOC.**

**REVISION RECORD**

**PAGE**

**1/17**

<b>NO.</b>	<b>DATE</b>	<b>DESCRIPTION</b>	<b>ITEM</b>	<b>PAGE</b>	<b>APPROVED</b>
1	2005.05	INITIAL ISSUED	ALL	ALL	LU BOO
2	2007.04	Added further information of LED backlight	4	4/20	
3	2008.01	Adopt logos on the cover for fast reference	-	Cover	
4	2008.10	Deleted "N = No Ic" from CODE2	-	Code System	
5	2008.10	Added CODE "B" for DFSTN version in CODE7	-	Code System	

**BOOKBINDING AREA**



**FORDATA ELECTRONIC CO.,LTD**  
**PROFESSIONAL LCD SUPPLIER FROM CHINA**

**STANDARD  
DOC.**

**CODE SYSTEM  
STANDARD COB**

**PAGE**

**2/17**

<b>1</b>	<b>2</b>	<b>3</b>	<b>4</b>	<b>5</b>	<b>6</b>	<b>7</b>	<b>8</b>	<b>9</b>	<b>10</b>	<b>11</b>	<b>12</b>	<b>13</b>	<b>14</b>	<b>15</b>	<b>16</b>
<b>FD</b>	<b>C</b>	<b>C</b>	<b>08</b>	<b>01</b>	<b>A</b>	<b>F</b>	<b>L</b>	<b>Y</b>	<b>Y</b>	<b>B</b>	<b>W</b>	<b>5</b>	<b>2</b>	<b>L</b>	<b>E</b>

<b>No.</b>	<b>REMARKS</b>	<b>DESCRIPTION</b>
1	COMPANY ABBRAVIATED	FD = FORDATA
2	IC packing	C = Chip On Board      G = Chip On Glass      T = TAB
3	LCM type	C = Character      G = Graphic
4	Chyarakter	08, 10, 12, 16, 20, 24, 40, = Character number Per line
	Graphic	80, 100, 120, 122, 128, 160 ... .. = Row Dots Quantity
5	Character	01, 02, 04, = Character Lines
	Graphic	32, 64, 80, 128, 160 ... .. =Column Dots Quantity
6	Serial Number	A~Z
7	Polarizer type	R = Positive Reflective      F = Positive Transflective M = Positive Transmissive      N = Negative Transmissive E = Negative, Transflective B = Negative, Dual optical compensation (for FSTN type only)
8	Backlight type	N = No Backlight      S = Edge Type LED Backlight L = Array Type LED Backlight      F = EL backlight with Invertor E = EL backlight without Invertor      T = CCFL backlight with Invertor C = CCFL backlight without Invertor
9	Backlight color	N = No Backlight      Y = Yellow-Green      W = White R = Red      A = Amber      C = Blue-Green B = Blue      G = Green
10	LCD panel type	T = TN      H = HTN      Y = Yellow-Green STN G = Gray STN      B = Blue STN      F = FSTN
11	Viewing angle	B = Bottom 6:00      T = Top 12:00      R = Right 3:00      L = Left 9:00
12	Operation temperature range	S = 0°C ~ 50°C (Single Supply Voltage)      D = 0°C ~ 50°C (Dual Supply Voltage) W = -20°C ~ 70°C (Single Supply Voltage)      H = -20°C ~ 70°C (Dual Supply Voltage) T = -30°C ~ 80°C (Single Supply Voltage)      E = -30°C ~ 80°C (Dual Supply Voltage)
13	Driving Voltage	1 : Vlcm = 3.0V, No / EL / CCFL Backlight or Vlcm = 3.0V, Vled = LED voltage, (Via AK) 2 : Vlcm = 3.6V, Vled = 5.0V (Not via AK) 3 : Vlcm = 3.6V, Vled = LED voltage, (Not via AK) 4 : Vlcm = 5.0V, Vled = LED voltage, (Not via AK) 5 : Vlcm = 5.0V, Vled = 5.0V (Not via AK) 6 : Vlcm = 5.0V, No / EL / CCFL Backlight or Vlcm = 5.0V, Vled = LED voltage, (Via AK) 7 : Vlcm = 3.6V, No / EL / CCFL Backlight or Vlcm = 3.6V, Vled = LED voltage, (Via AK) 8 : Vlcm = 3.0V, Vled = 5.0V 9 : Vlcm = 3.0V, Vled = LED voltage, (Not via AK)
14	Backlight Connect Method	0 = PIN1 LED-, PIN2 LED+ 1 = PIN15(17/19) LED+, PIN16(18/20) LED- 2 = PIN15(17/19) LED-, PIN16(18/20) LED+ 3 = PIN15(17/19) LED+, PIN16(18/20) NC 4 = PIN15(17/19) NC, PIN16(18/20) LED+ 5 = PINA LED+, PINK LED- 6 = No / EL / CCFL Backlight
15	IC Manufacturer	X = SAMSUNG      L = SUNPLUS      S = SITRONIX T = TOSHIBA      E = EPSON      H = HOLTEK Q = ASLIC      N = CIMTEK      P = PRINCETON
16	Font Set	R = English - Russia      E = English - Japanese U = English - Europe      H = English - Hebrew K = English - Europe      N = NO FONT SET



<b>1. GENERAL SPECIFICATIONS -----</b>	<b>Page 4</b>
<b>2. MECHANICAL SPECIFICATIONS -----</b>	<b>Page 4</b>
<b>3. ABSOLUTE MAXIMUM RATINGS -----</b>	<b>Page 4</b>
<b>4. ELECTRONICAL CHARACTERISTIC -----</b>	<b>Page 4</b>
<b>5. OPTICAL CHARACTERISTICS -----</b>	<b>Page 5</b>
<b>6. DC CHARACTERISTICS -----</b>	<b>Page 6</b>
<b>7. AC CHARACTERISTICS -----</b>	<b>Page 6</b>
<b>8. EXTERNAL DIMENSION-----</b>	<b>Page 8</b>
<b>9. PIN ASSIGNMENT -----</b>	<b>Page 9</b>
<b>10. BLOCK DIAGRAM-----</b>	<b>Page 9</b>
<b>11. POWER SUPPLY -----</b>	<b>Page 9</b>
<b>12. FUNCTIONAL DESCRIPTION -----</b>	<b>Page 10</b>
<b>13. INSTRUCTION -----</b>	<b>Page 13</b>
<b>14. DESCRIPTION OF COMMAND -----</b>	<b>Page 14</b>
<b>15. APPLICATION EXAMPLE -----</b>	<b>Page 16</b>
<b>16. PACKING DETAIL -----</b>	<b>Page 17</b>



## 1. GENERAL SPECIFICATIONS

ITEM	NOMINAL DIMENSIONS / AVAILABLE OPTIONS
DISPLAY FORMAT	128 X 64 DOT MATRIX
LCD PANEL OPTIONS	STN (Yellow-green color)
POLARIZER OPTIONS	Positive, Transflective
BACKLIGHT OPTIONS	Array type LED Backlight (Yellow-green color)
VIEWING ANGLE OPTIONS	6:00 ( Bottom )
TEMPERATURE RANGE OPTIONS	Wide temp. range ( -20°C ~ 70°C )
CONTROLLER IC	SAMSUNG
DC-DC IC	Without
DISPLAY DUTY	1/64
DRIVING BIAS	1/9

## 2. MECHANICAL SPECIFICATIONS

<b>OVERALL SIZE</b>	LED backlight version :			63.2 x 52.2 x max 10.5	mm
<b>VIEWING AREA</b>	54.0W x 36.0H	mm	<b>HOLE-HOLE</b>	57.2W x 51.0H	mm
<b>DOT SIZE</b>	0.35W x 0.45H	mm	<b>DOT PITCH</b>	0.04W x 0.04H	mm
<b>WEIGHT (EL BKL)</b>	—	g	<b>WEIGHT (LED BKL)</b>	40.0	g

## 3. ABSOLUTE MAXIMUM RATINGS

ITEM	SYMBOL	CONDITION	MIN	MAX	UNIT
POWER SUPPLY ( LOGIC)	Vdd	25°C	-0.3	7.0	V
POWER SUPPLY (LCD)	V0	25°C	Vdd -19.0	Vdd +0.3	V
INPUT VOLTAGE	Vin	25°C	-0.3	Vdd +0.3	V
OPERATING TEMPERATURE	Vopr	—	-20	70	°C
STORAGE TEMPERATURE	Vstg	—	-30	80	°C

## 4. ELECTRONICAL CHARACTERISTIC\*

ITEM	SYMBOL	CONDITION	STANDARD			UNIT
			MIN	TYP	MAX	
Input voltage	Vdd	+5V	4.7	5.0	5.5	V
Supply current	Idd	Vdd=5V	—	2.1	—	mA
Recommended LCD driving voltage for normal temp. Version module	Vdd - V0	-20°C	8.70	—	9.20	V
		0°C	8.45	—	9.05	
		25°C	8.30	—	8.60	
		50°C	8.10	—	8.35	
		70°C	7.60	—	8.00	
LED forward voltage	Vf	25°C	3.9	—	4.5	V
LED forward current	If	25°C	—	300	—	mA
LED reverse Current	Ir	25°C	—	—	300	μA
LED Peak wave length	λp	25°C If = 300mA	568	—	575	nm
LED illuminance (Without LCD)	Lv	25°C If = 300mA	—	240	—	cd/m <sup>2</sup>
LED life time	—	25°C If =300mA	9K**	—	—	Hours

\* The above data are for reference only.

\*\* The warranty period of FORDATA LCD module is 1YEAR counted from the date shown on the label of products.

**5. OPTICAL CHARACTERISTIC**

FOR TN TYPE LCD MODULE (TA=25 °C, Vdd=5.0V ± 0.25V)						
ITEM	SYMBOL	CONDITION	MIN	TYP	MAX	UNIT
VIEWING ANGLE	$\phi 2 - \phi 1$	K=4	30	---	---	deg
	$\theta$		25			
CONTRAST RATIO	K	---	---	2	---	---
RESPONSE TIME(RISE)	TR	---	---	120	150	ms
RESPONSE TIME(FALL)	TF	---	---	120	150	ms

FOR STN TYPE LCD MODULE (TA=25 °C, Vdd=5.0V ± 0.25V)						
ITEM	SYMBOL	CONDITION	MIN	TYP	MAX	UNIT
VIEWING ANGLE	$\phi 2 - \phi 1$	K=4	40	---	---	deg
	$\theta$		60			
CONTRAST RATIO	K	---	---	6	---	---
RESPONSE TIME(RISE)	TR	---	---	150	250	ms
RESPONSE TIME(FALL)	TF	---	---	150	250	ms

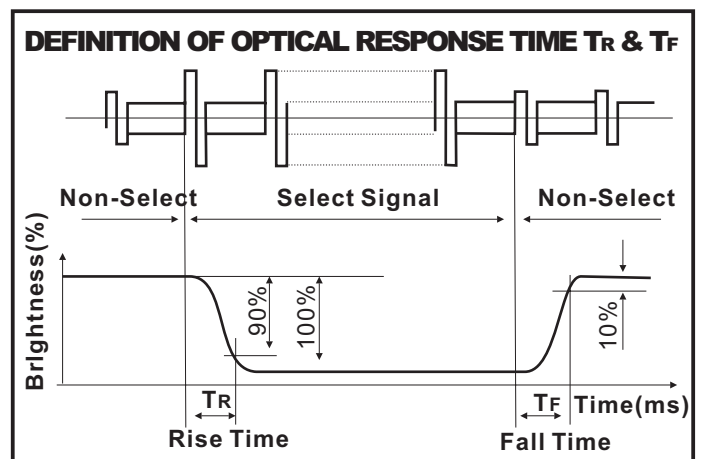
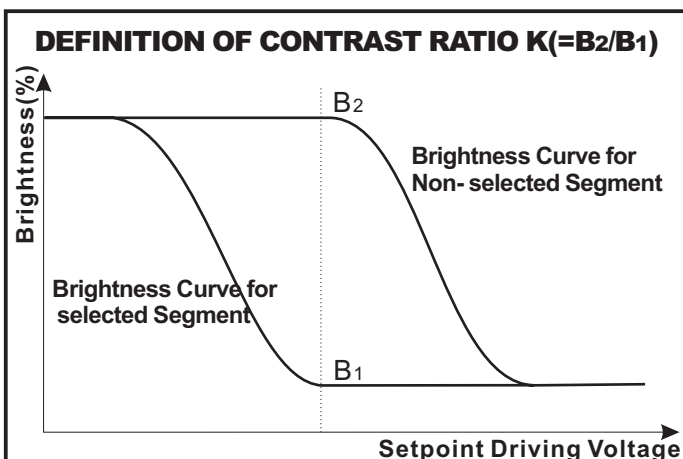
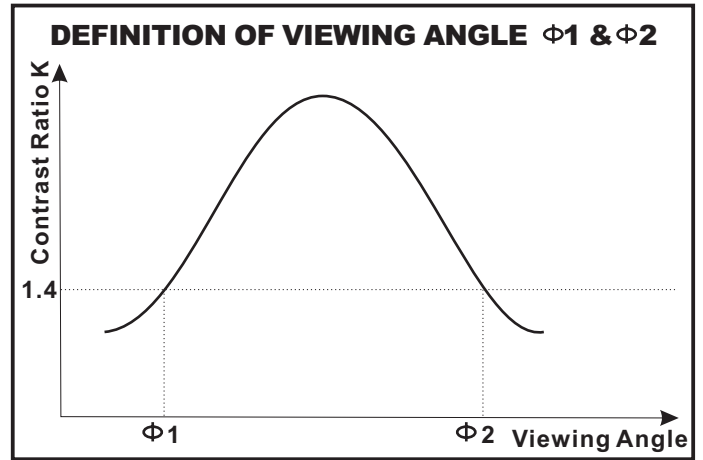
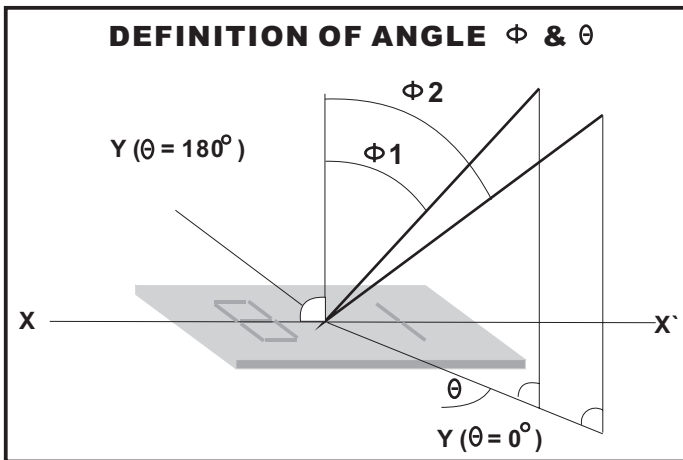



## 6. DC CHARACTERISTIC

(Unless otherwise stated, VDD= +5V ± 10%, VSS=0V, Ta=25°C)

Parameter	Symbol	Condition	Min.	Typ.	Max.	Unit
High Level Input Voltage	VIH1	---	0.7VDD	---	VDD	V
	VIH2	---	0.7VDD	---	VDD	V
Low Level Input Voltage	VIL1	---	0	---	0.3VDD	V
	VIL2	---	0	---	0.8	V
High Level Output Voltage	VOH	IOH = - 200 $\mu$ A	2.4	---	---	V
Low Level Output Voltage	VOL	IOL = 1.6 mA	---	---	0.4	V
Input Leakage Current	ILKG	VIN = VDD to VSS	-1.0	---	1.0	$\mu$ A
Three-State (OFF) Input Current	ITSL	VIN = VDD to VSS	-5.0	---	5.0	$\mu$ A
Operating Current	IDD1	During Display	---	---	100	$\mu$ A
	IDD2	During Access, Access Cycle = 1MHz	---	---	500	$\mu$ A

## 7. AC CHARACTERISTIC

Characteristic	Symbol	Min	Typ	Max	Unit
E Cycle	t <sub>c</sub>	1000	—	—	ns
E High Level Width	t <sub>WH</sub>	450	—	—	ns
E Low Level Width	t <sub>WL</sub>	450	—	—	ns
E Rise Time	t <sub>R</sub>	—	—	25	ns
E Fall Time	t <sub>F</sub>	—	—	25	ns
Address Setup Time	t <sub>ASU</sub>	140	—	—	ns
Address Hold Time	t <sub>AH</sub>	10	—	—	ns
Data Setup Time	t <sub>DSU</sub>	200	—	—	ns
Data Delay Time	t <sub>D</sub>	—	—	320	ns
Data Hold Time (Write)	t <sub>DHW</sub>	10	—	—	ns
Data Hold Time (Read)	t <sub>DHR</sub>	20	—	—	ns





**7.1 WRITE MODE TIMING DIAGRAM**

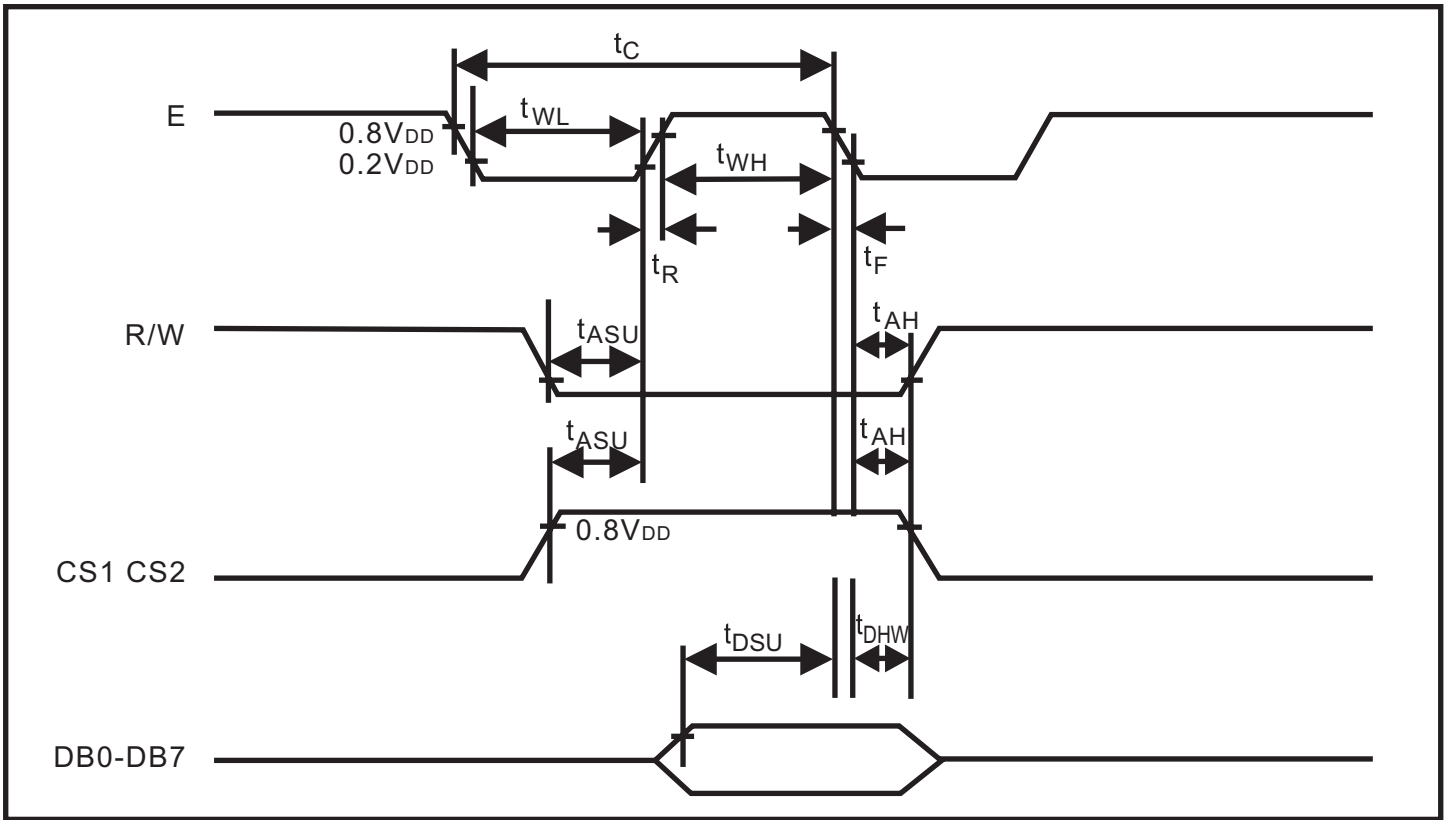

**7.2 READ MODE TIMING DIAGRAM**

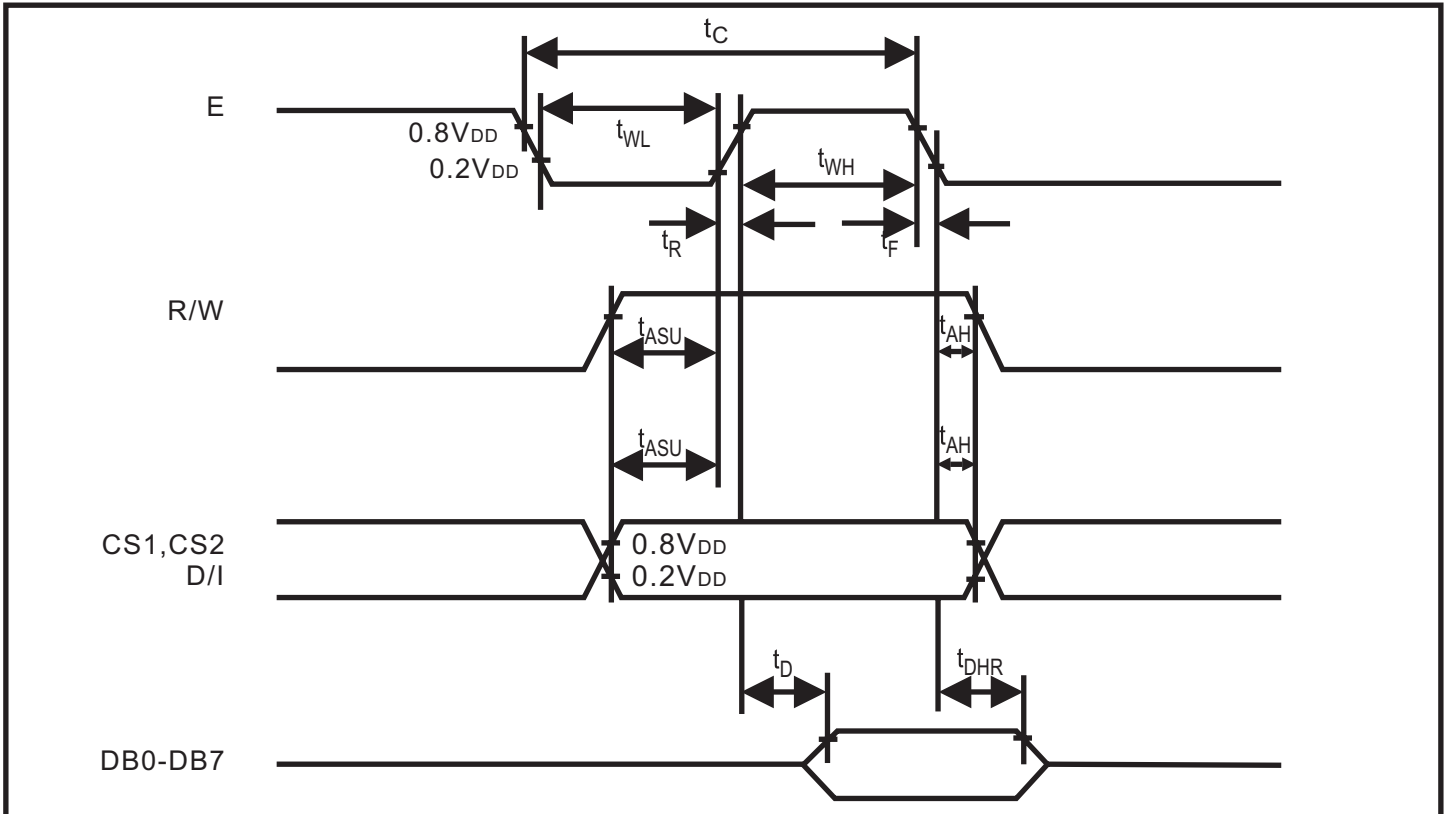



**8.EXTERNAL DIMENSIONS**

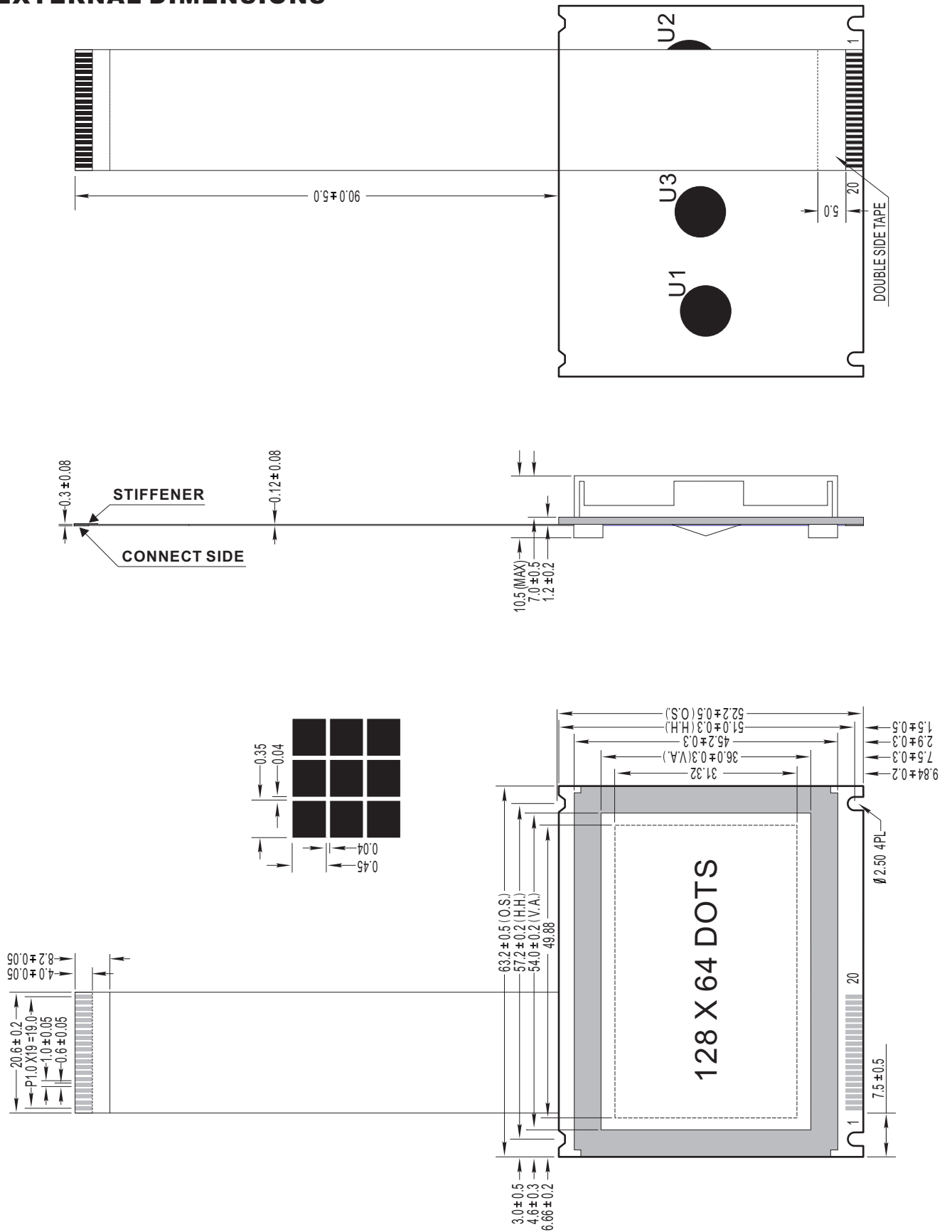

**8. PIN ASSIGNMENT**

PIN NO.	SYMBOL	FUNCTION	REMARK	
1	Vdd	Power Supply		
2	Vss			+5V
3	V0			0V
4	V0	Contrast Adjust		
4	DB0	Data Bit 0		
5	DB1	Data Bit 1		
6	DB2	Data Bit 2		
7	DB3	Data Bit 3		
8	DB4	Data Bit 4		
9	DB5	Data Bit 5		
10	DB6	Data Bit 6		
11	DB7	Data Bit 7		
12	CS2	When CS1=H, CS2=L, select U2	The same functions in different descriptions	
13	CS1	When CS1=L, CS2=H, select U3		
14	RST	Reset signal		
15	R/W	Read / Write		
16	D/I	H/L H: Data, L: Instruction code		
17	E	Chip Enable signal		
18	Vss	Ground		
19	LED+	Anode of LED Unit	+5V	
20	LED-	Cathode of LED Unit	0V	

**9. BLOCK DIAGRAM**

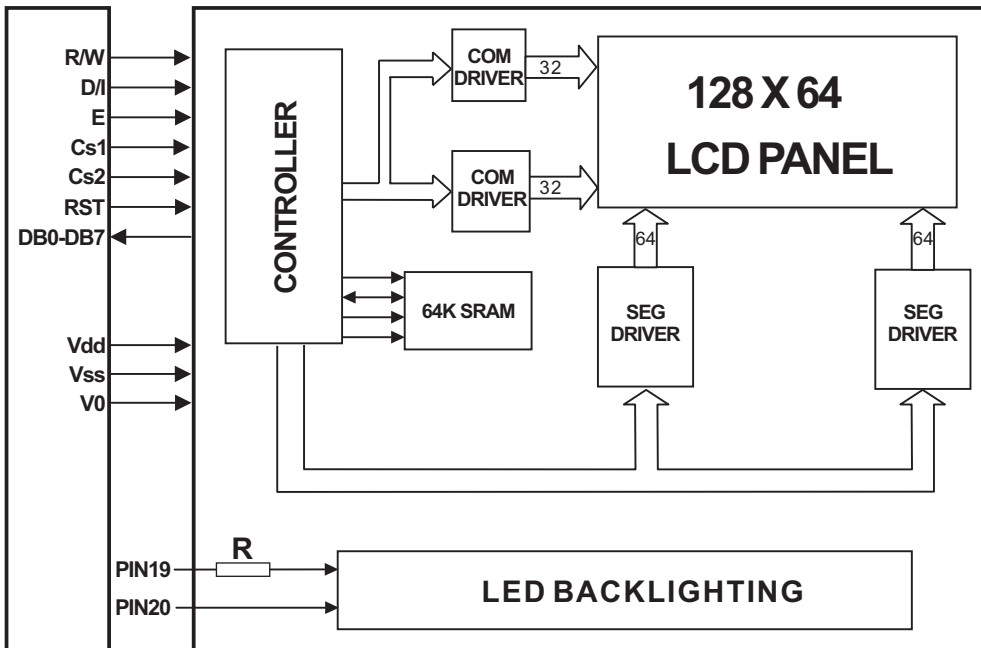

**10. POWER SUPPLY**

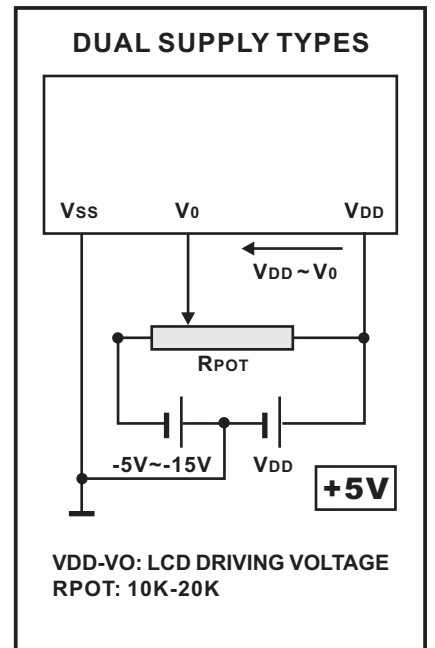



## 12. FUNCTIONAL DESCRIPTION

### 12.1 RESET

The system can be initialized by setting the RSTB to LOW when turning the power ON or by instruction from the MPU. When the RSTB is set to LOW, the following condition occurs:

1. The Display is turned OFF.
2. The Display Start Line register is set to 0 (Z-Address 0).

No instructions except the status read can be executed when the RSTB is LOW. This means that in order to execute other instructions, the RSTB must be cleared by setting DB4 to 0 and the DB7 set to 0 by status read instruction.

The table below shows the power supply initial conditions.

Parameter	Symbol	Min.	Typ.	Max.	Unit
Reset Time	$t_{RS}$	1.0	-	-	$\mu\text{S}$
Rise Time	$t_R$	-	-	200	$\text{nS}$

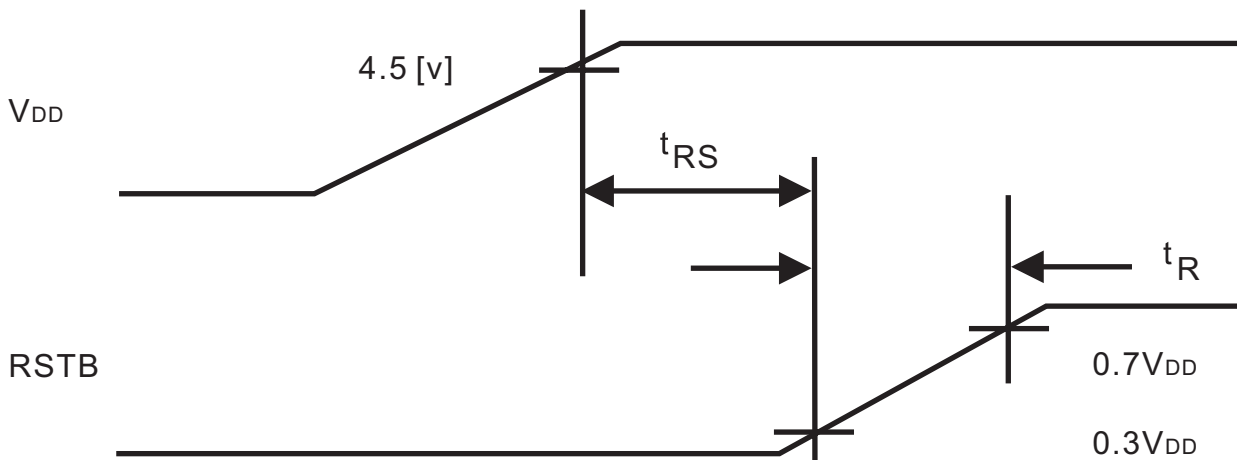



## 12.2 BUSY FLAG

The busy flag (DB7) is used to determine whether PT6608 is operating or not. When the busy flag is HIGH, internal operation is taking place. When the busy flag is LOW, PT6608 can accept data or instructions. The busy check diagram is shown below.

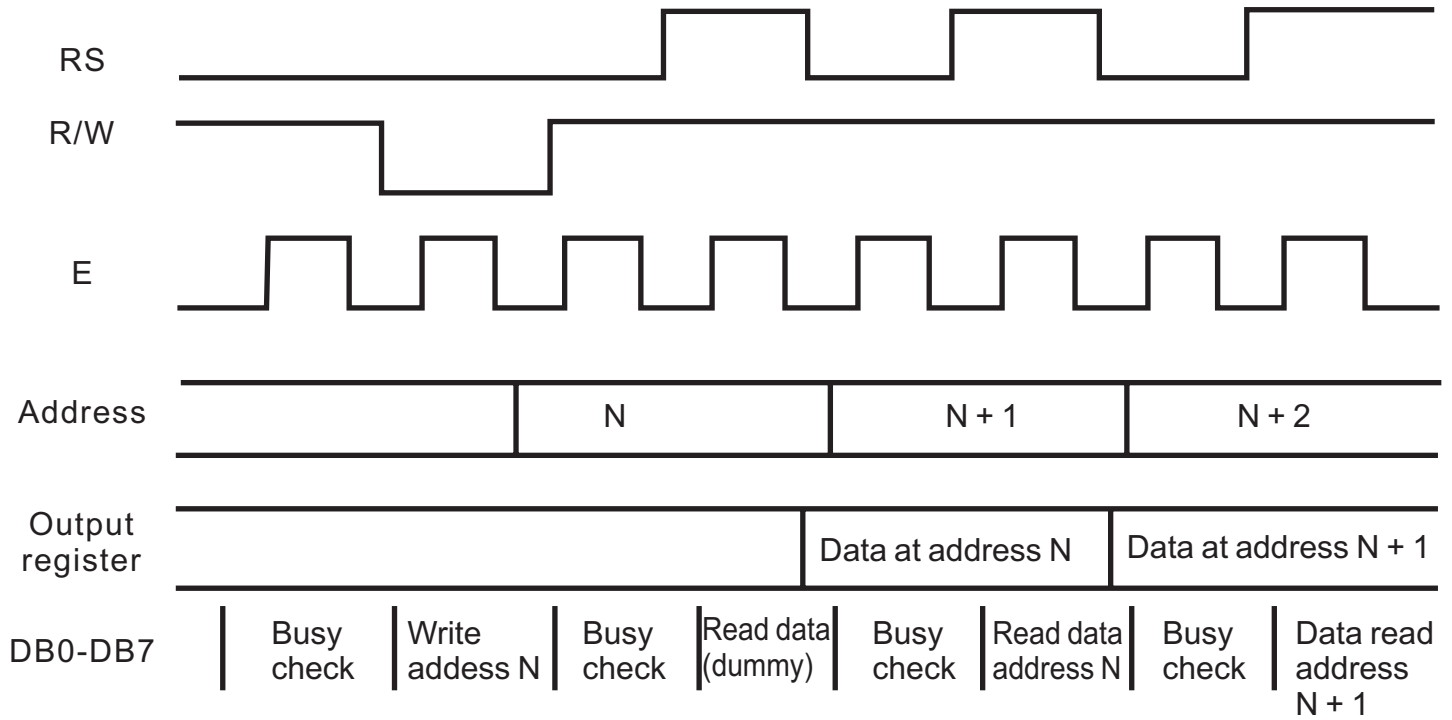

The busy flag diagram is shown below.

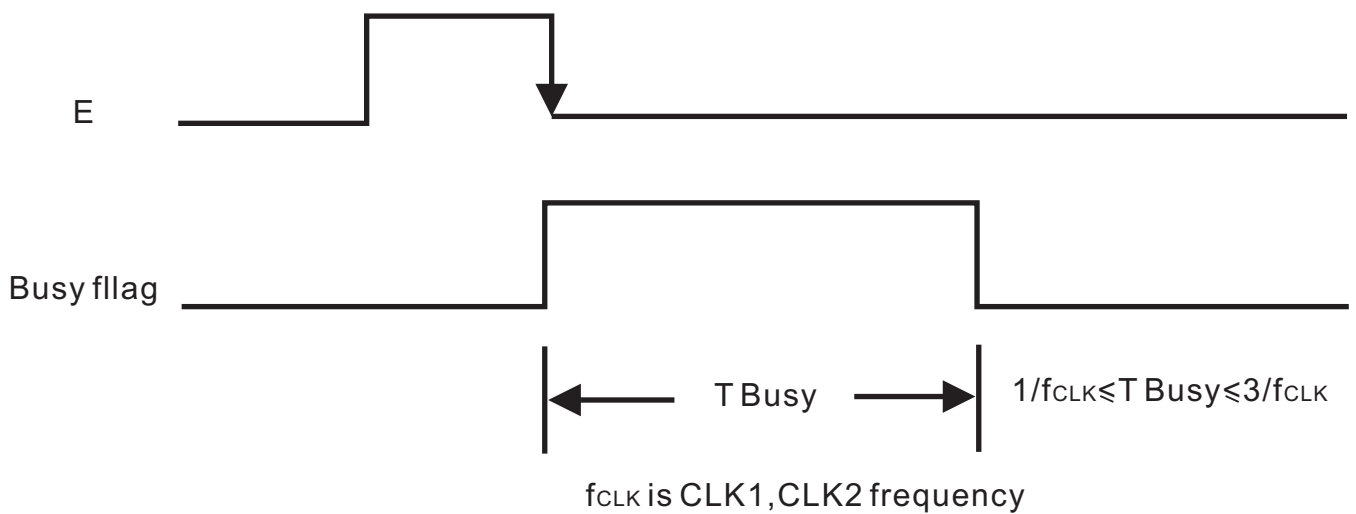



### 12.3 RELATION BETWEEN DISPLAY PATTERN AND DRIVERS

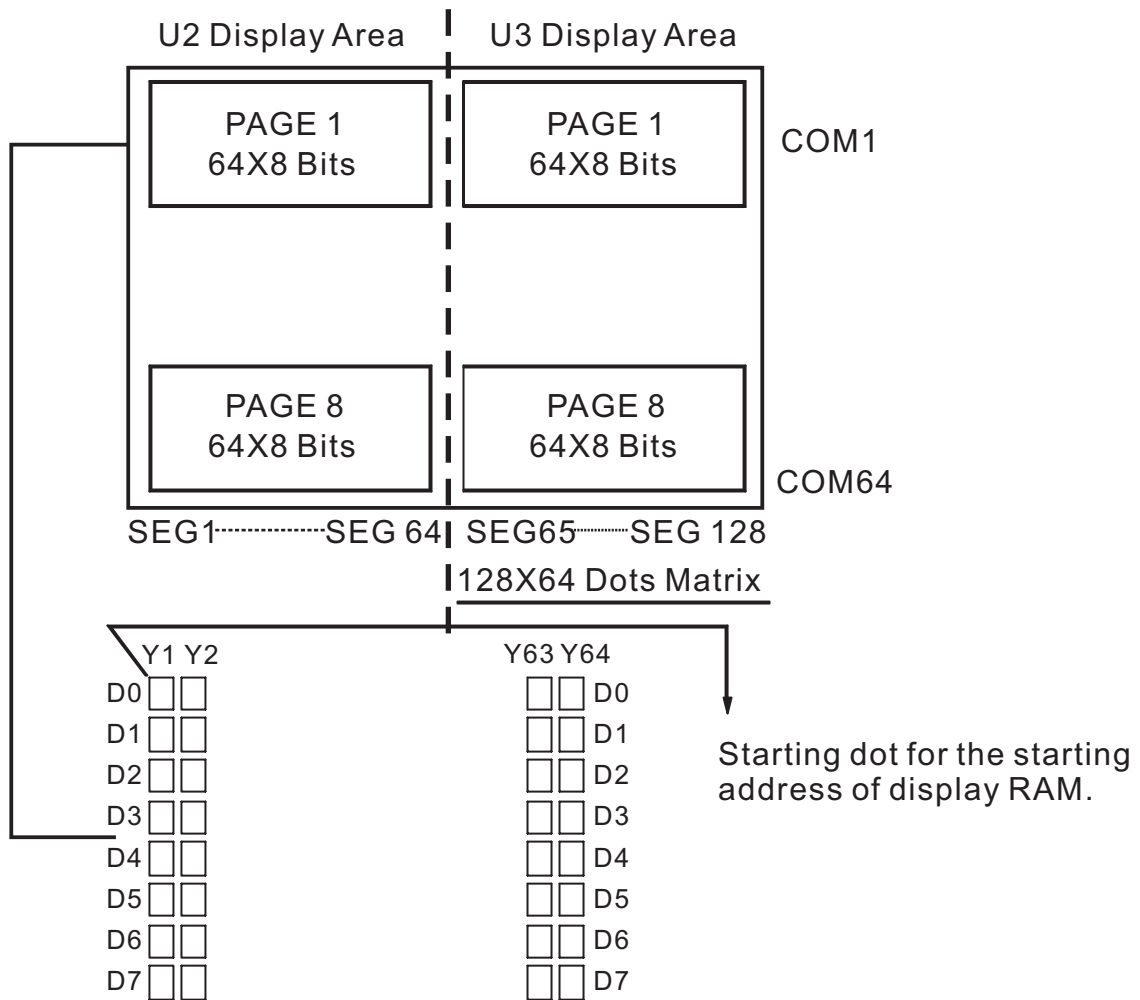

Each segment driver has 8 pages RAM, and each page has 64x8 bits RAM. D0~D7 are 8 bits transmitted data, where D0 is LSB and D7 is MSB.

### 12.4 DISPLAY DATA RAM

The Display Data RAM is used to store the display data for the liquid crystal display. Write data 1 is indicates an ON State of the LCDs dot matrix while the OFF State is written as 0. ADC Signal can control the Display Data RAM and the segment output. Please refer to the table below.

ADC *	Display Data
H	Y-Address 0:S1 to Y-Address 63:S64



**13. INSTRUCTION**

Instruction	RS	R/W	DB7	DB6	DB5	DB4	DB3	DB2	DB1	DB0	Function
Display ON/OFF	L	L	L	L	H	H	H	H	H	L/H	Controls the display on or off. Internal status and display RAM data is not affected. L:OFF H:ON
Set address (Y address)	L	L	L	H	Y address (0~63)					Sets the Y address in the Y address counter.	
Set Page (X address)	L	L	H	L	H	H	H	Page (0~7)		Sets the X address at the X address register.	
Display Start Line (Z address)	L	L	H	H	Display start line (0~63)					Indicates the display data RAM displayed at the top of the screen.	
Status Read	L	H	B U S Y	L	O N / O F F	R E S E T	L	L	L	L	BUSY L:Ready H:In operation ON/OFF L:Display ON H:Display OFF RESET L:Normal H:Reset
Write Display Data	H	L	Write Data								Writes data (DB0:7) into display data RAM,After writing instruction,Y address is increased by 1 automatically.
Read Display Data	H	H	Read Data								Reads data (DB0:7) from display data RAM to the data bus.



## 14. DESCRIPTION OF COMMAND

### Display On/Off

RS	R/W	DB7	DB6	DB5	DB4	DB3	DB2	DB1	DB0
0	0	0	0	1	1	1	1	1	D

The display data appears when D is 1 and disappears when D is 0.

Though the data is not on the screen with D=0, it remains in the display data RAM.

Therefore, you can make it appear by changing D=0 into D=1.

### Set Address(Y Address)

RS	R/W	DB7	DB6	DB5	DB4	DB3	DB2	DB1	DB0
0	0	0	1	AC5	AC4	AC3	AC2	AC1	AC0

Y address (AC0-AC5) of the display data RAM is set in the Y address counter.

An address is set by instruction and increased by 1 automatically by read or write operations of display data.

### Set Page(X Address)

RS	R/W	DB7	DB6	DB5	DB4	DB3	DB2	DB1	DB0
0	0	1	0	1	1	1	AC2	AC1	AC0

X address (AC0-AC2) of the display data RAM is set in the X address register.

Writing or reading to or from MPU is executed in this specified page until the next page is set.

### Display Start Line(Z Address)

RS	R/W	DB7	DB6	DB5	DB4	DB3	DB2	DB1	DB0
0	0	1	1	AC5	AC4	AC3	AC2	AC1	AC0

Z address (AC0-AC5) of the display data RAM is set in the display start line register and displayed at the top of the screen.

When the display duty cycle is 1/64 or others(1/32-1/64), the data of total line number of LCD screen, from the line specified by display start line instruction, is displayed.





### Status Read

RS	R/W	DB7	DB6	DB5	DB4	DB3	DB2	DB1	DB0
0	1	BUSY	0	ON/OFF	RESET	0	0	0	0

● **BUSY**

When BUSY is 1,the Chip is executing internal operation and no instructions are accepted.  
 When BUSY is 0,the Chip is ready to accept any instructions.

● **ON/OFF**

When ON/OFF is 1,the display is on.  
 When ON/OFF is 0,the display is off.

● **RESET**

When RESET is 1,the system is being initialized.  
 In this condition, no instructions except status read can be accepted.  
 When RESET is 0,initializing has finished and the system is in the usual operation condition.

### Write Display Data

RS	R/W	DB7	DB6	DB5	DB4	DB3	DB2	DB1	DB0
1	0	D7	D6	D5	D4	D3	D2	D1	D0

Writes data (D0-D7) into the display data RAM.  
 After writing instruction, Y address is increased by 1 automatically.

### Read Display Data

RS	R/W	DB7	DB6	DB5	DB4	DB3	DB2	DB1	DB0
1	1	D7	D6	D5	D4	D3	D2	D1	D0

Reads data (D0-D7) from the display data RAM.  
 After reading instruction, Y address is increased by 1 automatically.

## 15. APPLICATION EXAMPLE

### Application Flowchart

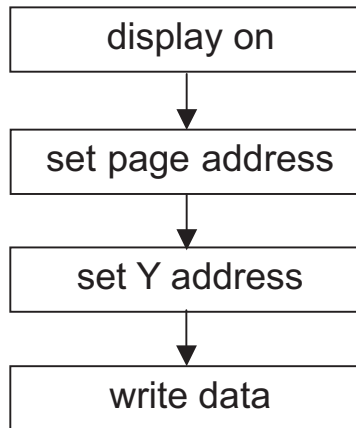

### Application Circuit

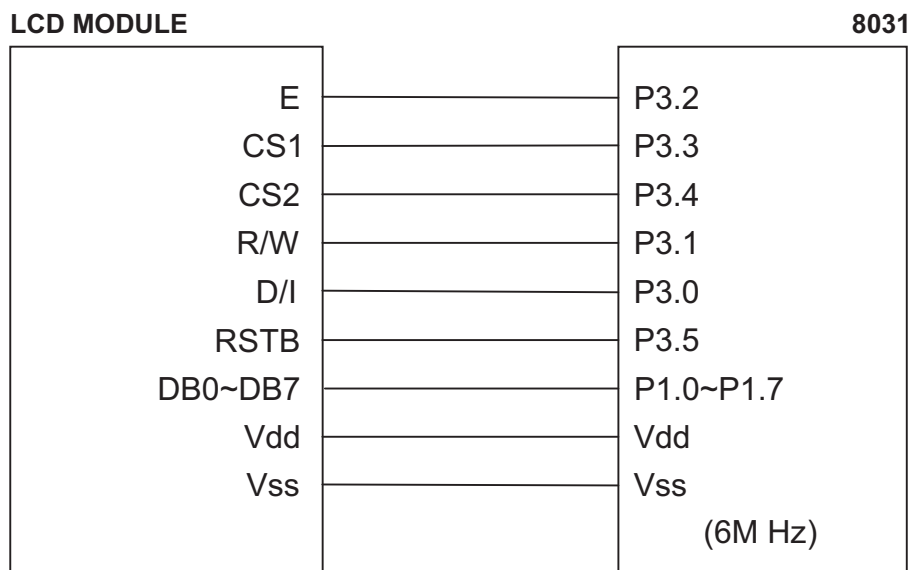

 <b>FORDATA ELECTRONIC CO.,LTD</b> PROFESSIONAL LCD SUPPLIER FROM CHINA	<b>PRODUCT SPEC.</b>	<b>MODE NO.</b>	<b>PAGE 17/17</b>
		FDCG12864M-FLYYBH-51XN	

**16. PACKING DETAIL**

WITH LED BKL	WITHOUT LED BKL
45 PCS/BOX	45 PCS/BOX
8 BOXES/CARTON	8 BOXES/CARTON
360 PCS/CARTON	360 PCS/CARTON
19.00 KGS/CTN(G.W.)	17.00 KGS/CTN(G.W.)
0.07 M <sup>3</sup> /CARTON	0.07 M <sup>3</sup> /CARTON

NOTE
1. The weight is estimated for reference only.
2. Packing detail may be changed without notice.

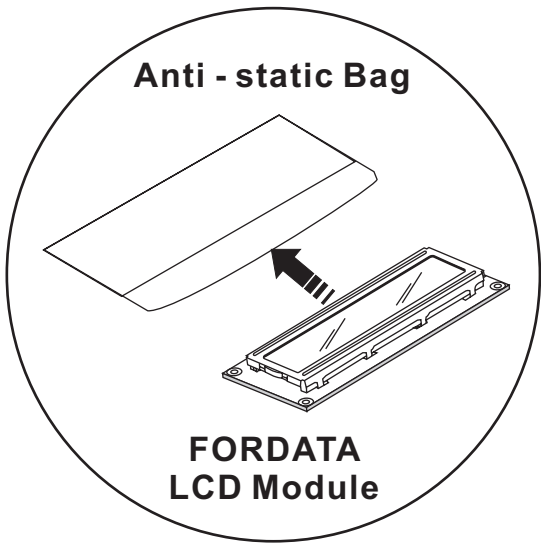

**BOX** 

**CARTON** 

