

BAS70

Surface Mount Schottky Barrier Single/Dual Diodes Schottky-Barrier Einzel-/Doppel-Dioden für die Oberflächenmontage

Version 2010-01-18

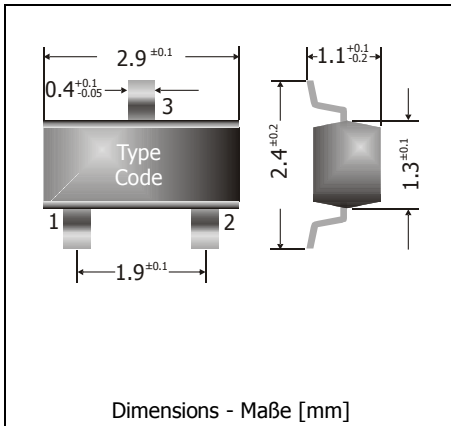

Power dissipation – Verlustleistung	310 mW
Repetitive peak reverse voltage Periodische Spitzensperrspannung	70 V
Plastic case Kunststoffgehäuse	SOT-23 (TO-236)
Weight approx. – Gewicht ca.	0.01 g
Plastic material has UL classification 94V-0 Gehäusematerial UL94V-0 klassifiziert	
Standard packaging taped and reeled Standard Lieferform gegurtet auf Rolle	



Maximum ratings (T_A = 25°C)

Grenzwerte (T_A = 25°C)

per diode / pro Diode	BAS70-series	
Power dissipation – Verlustleistung ¹⁾	P _{tot}	310 mW ²⁾
Max. average forward current – Dauergrenzstrom (dc)	I _{FAV}	200 mA ²⁾
Repetitive peak forward current – Periodischer Spitzenstrom	I _{FRM}	300 mA ²⁾
Non repetitive peak forward surge current Stoßstrom-Grenzwert	I _{FSM}	600 mA
Repetitive peak reverse voltage – Periodische Spitzensperrspannung	V _{R RM}	70 V
Junction temperature – Sperrschichttemperatur	T _j	-55...+150°C
Storage temperature – Lagerungstemperatur	T _s	-55...+150°C

Characteristics (T_j = 25°C)

Kennwerte (T_j = 25°C)

Forward voltage Durchlass-Spannung	I _F = 1 mA I _F = 15 mA	V _F V _F	< 410 mV < 1000 mV
Leakage current – Sperrstrom ³⁾	V _R = 50 V	I _R	< 100 nA
Max. junction capacitance – Max. Sperrschichtkapazität V _R = 0 V, f = 1 MHz		C _T	2 pF
Reverse recovery time – Sperrverzug I _F = 10 mA über/through I _R = 10 mA bis/to I _R = 1 mA		t _{rr}	< 5 ns
Thermal resistance junction to ambient air Wärmewiderstand Sperrschicht – umgebende Luft		R _{thA}	< 400 K/W ²⁾

1 Total power dissipation of both diodes – Summe der Verlustleistungen beider Dioden

2 Mounted on P.C. board with 3 mm² copper pad at each terminal
Montage auf Leiterplatte mit 3 mm² Kupferbelag (Lötpad) an jedem Anschluss

3 Tested with pulses t_p = 300 μs, duty cycle ≤ 2% – Gemessen mit Impulsen t_p = 300 μs, Schaltverhältnis ≤ 2%

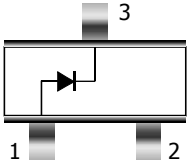
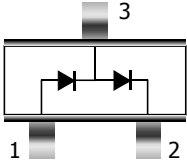
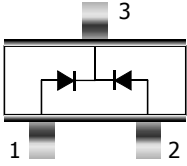
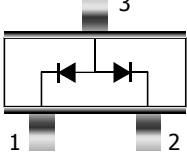
Pinning – Anschlussbelegung		Marking – Stempelung
	Single diode einzelne Diode 1 = A 2 = n.c. 3 = C	BAS70 = 73
	Dual diode, series connection Doppeldiode, Reihenschaltung 1 = A1 2 = C2 3 = C1/A2	BAS70-04 = 74
	Dual diode, common cathode Doppeldiode, gemeinsame Kathode 1 = A1 2 = A2 3 = C1/C2	BAS70-05 = 75
	Dual diode, common anode Doppeldiode, gemeinsame Anode 1 = C1 2 = C2 3 = A1/A2	BAS70-06 = 76

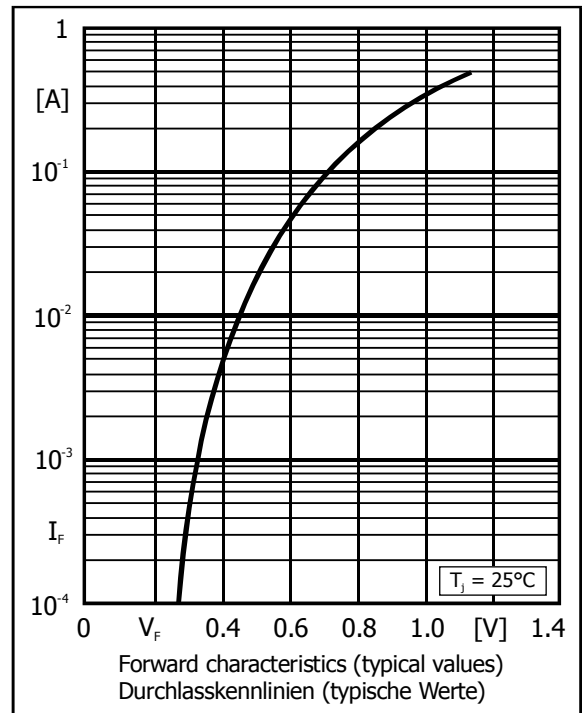
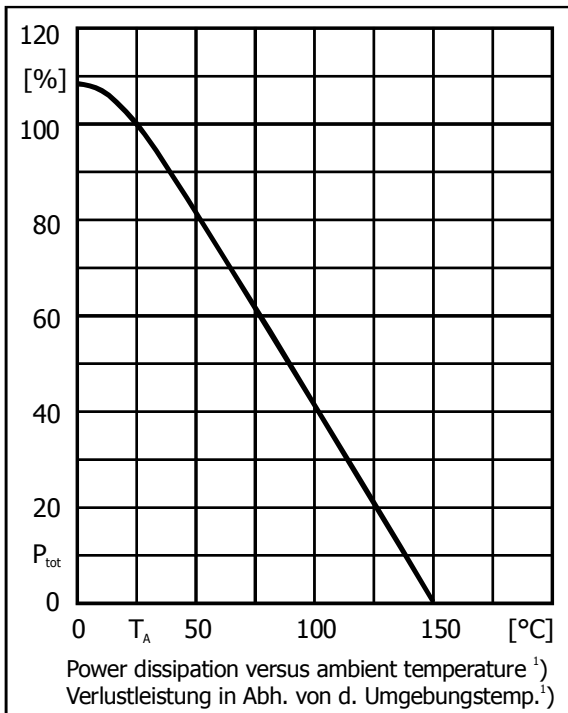

1 Mounted on P.C. board with 3 mm² copper pad at each terminal
 Montage auf Leiterplatte mit 3 mm² Kupferbelag (Löt-pad) an jedem Anschluss