

REV.	DESCRIPTION	DRAWN	CHECKED	APPROVED
A	NEW RELEASE	JLZ 03/12/15'		

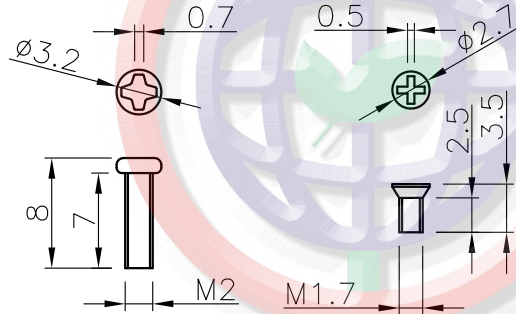
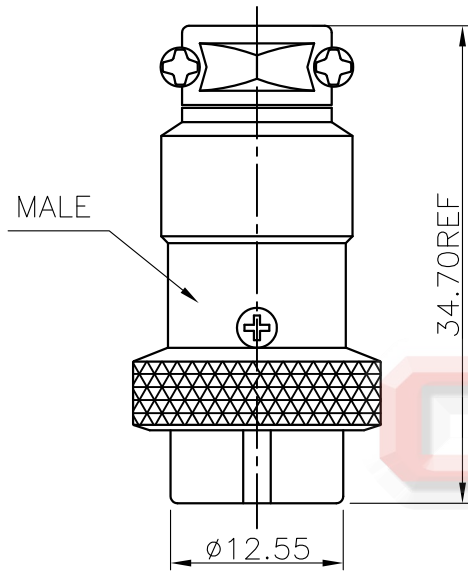

NOTES:

1. SPECIFICATION

- .CURRENT RATING: 5A Max.
- .DIELECTRIC WITH STANDING VOLTAGE: 500V(AC)
- .CONTACT RESISTANCE: 50m Ω Max.
- .INSULATION RESISTANCE: 1000M Ω (DC)Min

2. PRODUCT NUMBER CODE:

DS1110 - X X X X

CONTACT PLATING
6: TIN

COLOR OF HOUSING:
W: WHITE
B: BLACK

CONNECTOR TYPE
M: MALE

No. OF CONTACTS
2 3 4 5 6 7 8 9

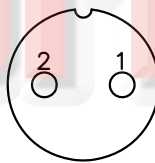

2 PIN

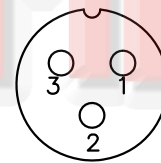

3 PIN



4 PIN

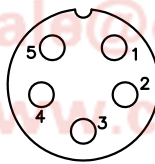

5 PIN

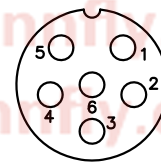

6 PIN

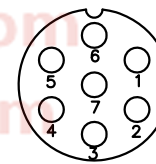

7 PIN

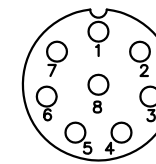

8 PIN

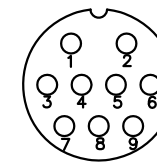

9 PIN

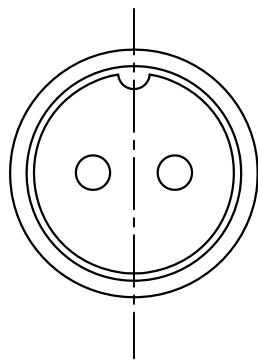

Tel:86-574-63508787

Fax:86-574-63510817

E-mail:sales@connfly.com

http://www.connfly.com

Add:East Industry Zone KuangYan

Town Cixi Ningbo China

P.C:315333

GENERAL TOLERANCE		ANGLE TOLERANCE		PROJECTION		TITLE	MICRO JACK CONNECTOR	
X.	± 0.60	X.	$\pm 5'$	UNITS	mm			
.X	± 0.38	.X	$\pm 3'$	SHEET SIZE	A4	SERIES	DS1110 SERIES	
.XX	± 0.25	.XX	$\pm 2'$	晨翔电子有限公司 CONNFLY CONNFLY ELECTRONIC CO. LTD				
DRAWING TYPE		CUSTOMER						
SCALE	1:1	SHEET	1 OF 1					
DRAWING NO.		C-DS1110-XXXX-A						