

RoHS
Compliant
Drawing For
Reference Only

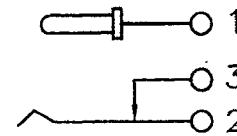

SCHMATEC

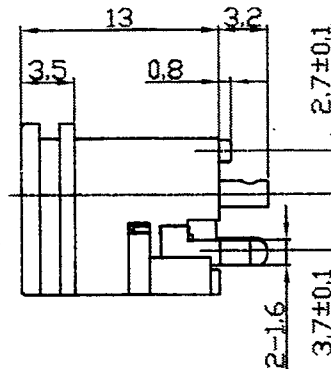
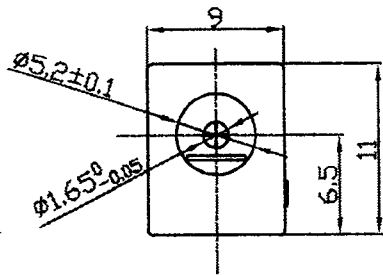
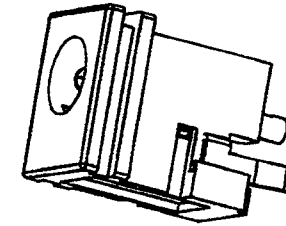
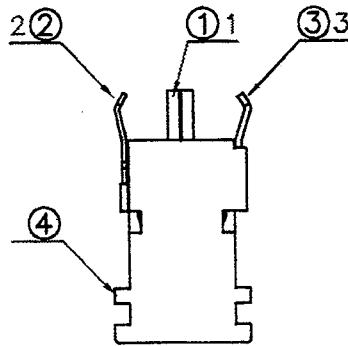
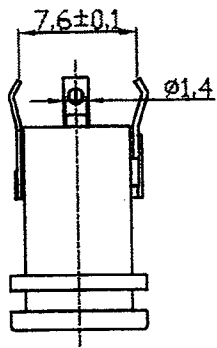
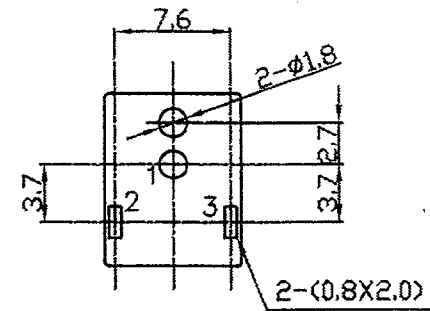

P. C. B LAYOUT TOP VIEW

Technical requirement :

1. This product should meet EU RoHS related requirement.
2. The surface of plastic part should be without any crackle such as burr,lack,and so on phenomenon.
3. The surface of metal part should be without any defect such as scaur,nick,oxidation and plating problem.
4. The electronic performance should be the same as spec.
5. The un-specified tolerance is : -6 ± 0.2
$6\sim 20\pm 0.3$
$>20\pm 0.4$

規格 Specifications

額定負荷 Ratings	DC 12 V 1 A
絕緣電阻 Insulation Resistance	DC 500V 60 Sec. 100 m Ω Min
抗電強度 Dielectric Voltage	AC 500V (50~60Hz) 60 Sec.
操作力 Operating Force	插入力 (Insertion Force) 0.3 ~3Kgf
	拔出力 (Extraction Force) 0.3 ~3Kgf
負荷壽命 Operating Life With Load	5,000 次 Cycles

DCI DRAGON CITY INDUSTRIES LIMITED

Item Name	DC POWER JACK 1.65 MM	Tolerance :	Design	K.W Law	Remark	Scale
Item No.	DS-036(SL)	Unit : mm	Drawing	W.K Yeung	Remark	Material
			Check	K.L Wong	Remark	Drawing No. A307191200
			Approval	K.W Chan	Remark	Sheet