



DATE : 26. April.2011

SAMSUNG TFT-LCD

MODEL : LTI460AP01

The Information Described in this Specification is Preliminary and can be changed without prior notice

APPROVED BY Kwang-Soo Lee	DATE 26.April.2011	PREPARED BY Dong-Hyun Kim	DATE 26.April.2011
-------------------------------------	-----------------------	-------------------------------------	-----------------------

Application Engineering Part, LCD Division

Samsung Electronics Co . , LTD.

Contents

Revision History	-----	(3)
General Description	-----	(4)
General Information	-----	(4)
1. Absolute Maximum Ratings	-----	(5)
2. Application information for DID (Digital Information Display)	-----	(6)
3. Optical Characteristics	-----	(7)
4. Electrical Characteristics	-----	(10)
4.1 TFT LCD Module		
5. Input Terminal Pin Assignment	-----	(11)
5.1 Input Signal & Power : LVDS & 12V DC		
5.2 LVDS Interface		
5.3 Input Signals, Basic Display Colors and Gray Scale of Each Color		
6. Interface Timing	-----	(15)
6.1 Timing Parameters (DE only mode)		
6.2 Timing Diagrams of interface Signal (DE only mode)		
6.3 Power ON/OFF Sequence		
7. Outline Dimension	-----	(18)
8. Packing	-----	(20)
9. Marking & Others	-----	(22)
10. General Precaution	-----	(23)

*** Revision History**

Date	Rev. No	Page	Summary
April, 26, 2011	000	all	First issued

General Description

Description

LTI460AP01 is a active matrix liquid crystal display (LCD) that uses amorphous silicon TFT(Thin Film Transistor) as switching components. This model is composed of a TFT LCD panel, a driver circuit. The resolution of a 46.0" is 1366 x 768 and this model can display up to 16.7M colors with wide viewing angle of 89° or higher in all directions. This panel is intended to support applications to provide a excellent performance for Flat Panel Display such as Transparent Display Monitor, Show window, Kiosk etc.

Features

- RoHS compliance (Pb-free)
- High Transmittance
- PVA mode
- Wide viewing angle ($\pm 178^\circ$)
- High speed response
- WXGA (1366 x 768 pixels) resolution (16:9)
- Low power consumption
- DE(Data Enable) mode
- Interface –LVDS

Recommend

- Do not use liquid cleaner at LCD surface
- Use cover glass at LCD
- Clean Class : 100000 Class

General Information

Items	Specification	Unit	Note
Module Size	1058.1(H) x 635.3(V)	mm	± 0.5 mm
	8.0(T)		
Weight	5,000(Max.)	g	
Pixel Pitch	0.7455(H) x 0.7455(V)	mm	
Active Display Area	1018.353(H) x 572.544(V)	mm	
Surface Treatment	TBD		
Display Colors	8 bit – 16.7M	Color	
Number of Pixels	1366 x 768	pixel	
Pixel Arrangement	RGB Horizontal stripe		
Display Mode	Normally Black		

1. Absolute Maximum Ratings

If the condition exceeds maximum ratings, it can cause malfunction or unrecoverable damage to the device.

Item		Symbol	Min.	Max.	Unit	Note
Power Supply Voltage		V_{DD}	GND-0.5	13.2	V	(1)
Storage temperature		T_{STG}	5	40	°C	
Glass surface temperature (Operation)	Center	T_{CENTER}	0	40	°C	
	T. Uniformity	ΔT	-	10	°C	
Shock (non - operating)		S_{nop}	-	50	G	(2)
Vibration (non - operating)		V_{nop}	-	1.5	G	(3)

Note (1) $T_a = 25 \pm 2$ °C

(2) 20ms, sine wave, one time for $\pm X$, $\pm Y$, $\pm Z$ axis

(3) 10-300 Hz, Sweep rate 10min, 30min for X,Y,Z axis

Fig. Temperature and Relative humidity range

(5) Definition of test point

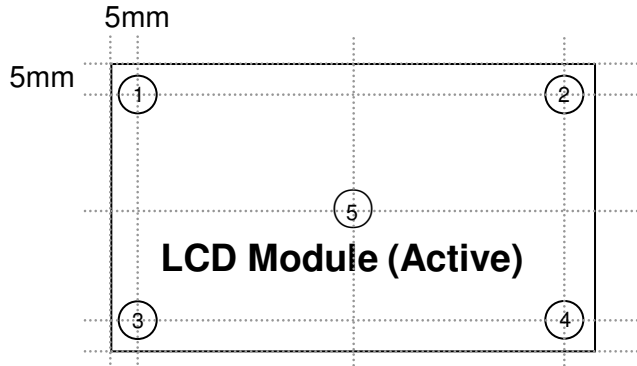

ΔT should be less than $10\text{ }^{\circ}\text{C}$ ($\Delta T = |T_{\text{CENTER}} - T_{\text{CORNER}}|$)

T_{CENTER} : Temperature of the center of the glass surface (Test point 5)

T_{CORNER} : Temperature of each edge of the glass surface (Test point 1~4)

2. Application information for DID (Digital Information Display)

A long-term display like DID application may cause uneven display including image retention. To optimize module's lifetime and function, several operating usages are required.

1. Normal operating condition

- Temperature: $20 \pm 15\text{ }^{\circ}\text{C}$
- Humidity: $55 \pm 20\%$
- Display pattern: moving picture or regular switchover display

Note) Long-term static information image may cause uneven display.

2. Operating usages under abnormal operating condition. Note (1)

- a. Ambient condition
 - Well-ventilated place is recommended to set up DID system.
- b. Power off and screen saver
 - Periodical power-off or screen saver is needed after long-term static display. Note (2)

3. Operating usages to protect uneven display due to long-term static information display

- a. Suitable operating time for E-DID : under 20 hours a day.
- b. Periodical display contents change from static image to moving picture.
 - Liquid crystal refresh time is required.
- c. Periodical background color and character (image) color change
 - Use different colors for background and character (image), respectively.
 - Change colors periodically.
- d. Avoid combination of background and character with large different luminance.

Note (1) Abnormal condition means every operating condition except normal operating condition.

Note (2) Moving picture or black pattern is strongly recommended for screen saver.

4. Lifetime in this spec is guaranteed only when DID is used under right operating usages.

3. Optical Characteristics

The optical characteristics should be measured in a dark room or equivalent.

Measuring equipment : BM-5A(TOPCON社), BM-7(TOPCON社), PR-650(Photo Reserch社)

(Ta = 25 ± 2°C, VDD = 12V, fv = 60Hz, f_{DCLK} = 78MHz)

Item	Symbol	Condition	Min.	Typ.	Max.	Unit	Note
Contrast Ratio (Center of screen)	C/R	Normal $\theta_L, R=0$ $\theta_U, D=0$	500	1000	-		(2) SR-3
Response Time	On/Off		Viewing Angle		TBD		msec
		T _{R+} T _F		RT	TBD		
Transmittance	%		12	15			(3) SR-3
Viewing Angle	Hor.	θ_L	75	TBD	-	Degree	(5) SR-3
		θ_R	75	TBD	-		
	Ver.	θ_U	55	TBD	-		
		θ_D	75	TBD	-		
Gamma Value			1.1	1.5	1.9		

Note (1) Measure Point

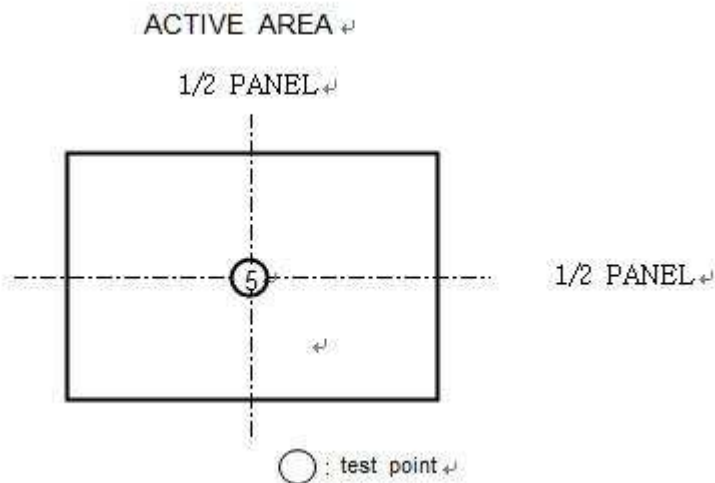

Note (2) Definition of Contrast Ratio (C/R)

: Ratio of gray max (Gmax) & gray min (Gmin) at the center point ⑤ of the panel

$$C/R = \frac{G \text{ max}}{G \text{ min}}$$

Gmax : Luminance with all pixels white

Gmin : Luminance with all pixels black

Note (3) Definition of Transmittance

Measure Pattern : Fully white

Ta = 25 ± 2°C

$$\frac{\text{The intensity of radiation(Output)}}{\text{The intensity of radiation(Input)}} * 100$$

Note (4) Definition of Response time : Average response time of all Gray to Gray except Tr, Tf
 $\frac{\sum [T^*(X-Y)]}{72}$

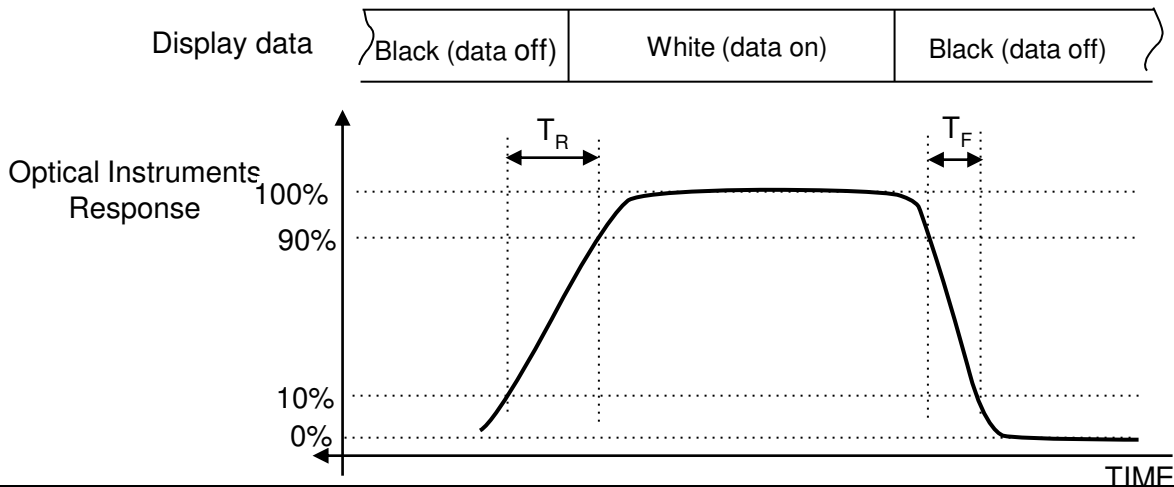

Gray to Gray Response Time

	Gray	End								
		0	31	63	95	127	159	191	223	255
Start	0		Tr(0-31)	Tr(0-63)	Tr(0-95)	Tr(0-127)	Tr(0-159)	Tr(0-191)	Tr(0-223)	Tr(0-255)
	31	Tf(31-0)		Tr(31-63)	Tr(31-95)	Tr(31-127)	Tr(31-159)	Tr(31-191)	Tr(31-223)	Tr(31-255)
	63	Tf(63-0)	Tf(63-31)		Tr(63-95)	Tr(63-127)	Tr(63-159)	Tr(63-191)	Tr(63-223)	Tr(63-255)
	95	Tf(95-0)	Tf(95-31)	Tf(95-63)		Tr(95-127)	Tr(95-159)	Tr(95-191)	Tr(95-223)	Tr(95-255)
	127	Tf(127-0)	Tf(127-31)	Tf(127-63)	Tf(127-95)		Tr(127-159)	Tr(127-191)	Tr(127-223)	Tr(127-255)
	159	Tf(159-0)	Tf(159-31)	Tf(159-63)	Tf(159-95)	Tf(159-127)		Tr(159-191)	Tr(159-223)	Tr(159-255)
	191	Tf(191-0)	Tf(191-31)	Tf(191-63)	Tf(191-95)	Tf(191-127)	Tf(191-159)		Tr(191-223)	Tr(191-255)
	223	Tf(223-0)	Tf(223-31)	Tf(223-63)	Tf(223-95)	Tf(223-127)	Tf(223-159)	Tf(223-191)		Tr(223-255)
255	Tf(255-0)	Tf(255-31)	Tf(255-63)	Tf(255-95)	Tf(255-127)	Tf(255-159)	Tf(255-191)	Tf(255-223)		
Toff										

Note (5) Definition of Viewing Angle
 : Viewing angle range (C/R ≥ 10)

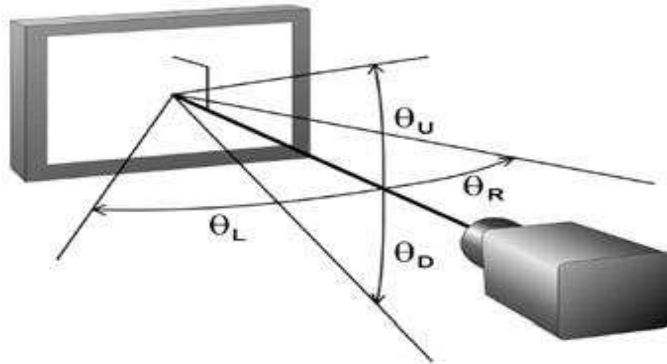

Note (6) Definition of Panel Front

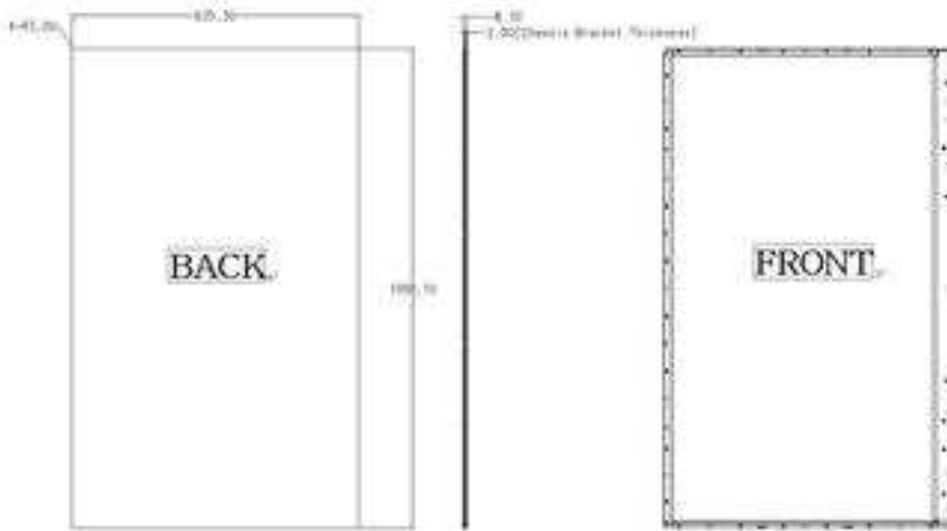

4. Electrical Characteristics

4.1 TFT LCD Module

The connector for display data & timing signal should be connected.

Ta = 25°C ± 2 °C

Item	Symbol	Min.	Typ.	Max.	Unit	Note	
Voltage of Power Supply	V _{DD}	10.8	12.0	13.2	V	(1)	
Current of Power Supply	(a) Black	I _{DD}	-	1500	1900	mA	(2),(3)
	(b) White		-	1200	1500	mA	
Interface Type	LVDS	: Tcon (merged)					
Vsync Frequency	f _V	48	60	65	Hz		
Hsync Frequency	f _H	44	48	53	kHz		
Main Frequency	f _{DCLK}	72	78	85	MHz		
Rush Current	I _{RUSH}	-	-	4	A	(4)	

Note (1) The ripple voltage should be controlled under 10% of V_{DD}.

(2) f_V = 60Hz, f_{DCLK} = 78MHz, V_{DD} = 12.0V, DC Current.

(3) Power dissipation check pattern (LCD Module only)

a) Black Pattern

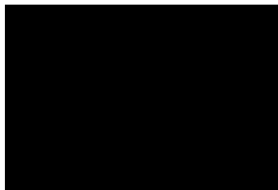

b) White Pattern



c) N-Pattern

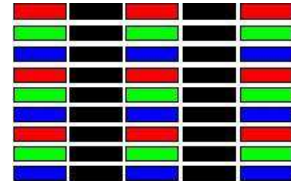

(4) Measurement Conditions

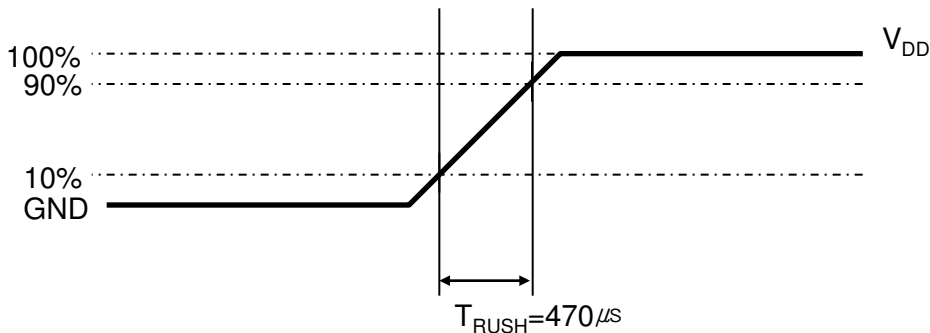

Rush Current I_{RUSH} can be measured when T_{RUSH} is 470 μs.

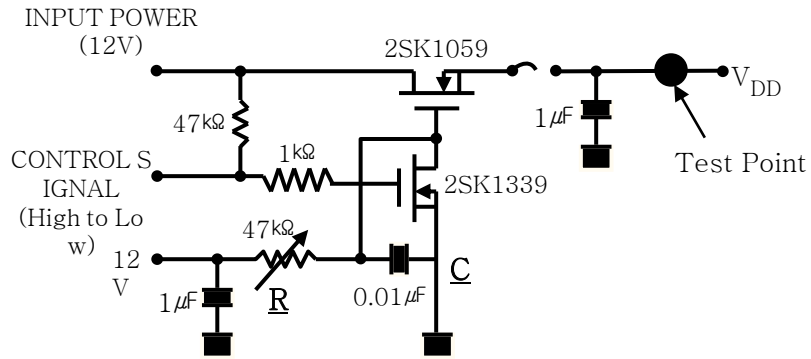

Control Signal : High(+12V) -->Low(Ground)
 All Signal lines to panel except for power 12V : Ground
 The rising time of supplied voltage is controlled to 470us by R and C value.

5. Input Terminal Pin Assignment

5.1 Input Signal & Power : LVDS & 12V DC

Connector DD1R030HA1 (JAE/UJU)

PIN No	Description	PIN No	Description
1	VDD(12V)	16	VDD(12V)
2	N.C(WPN)	17	RC_N
3	N.C(SCL_I)	18	RC_P
4	N.C(SDA_I)	19	GND
5	GND	20	R3_N
6	R0_N	21	R3_P
7	R0_P	22	GND
8	GND	23	BIST_EN
9	R1_N	24	LVDS_SEL
10	R1_P	25	N.C
11	GND	26	GND
12	R2_N	27	GND
13	R2_P	28	GND
14	GND	29	VDD(12V)
15	VDD(12V)	30	GND

(NOTE) N.C (NOT CONNECTED) : THIS PINS ARE ONLY USED FOR SEC INTERNAL OPERATIONS.

(NOTE1) BIST EN : HIGH(3.3V) → BIST Pattern Enable ,
LOW(GND) & Default → BIST Pattern Disable

(NOTE2) LVDS SELECTION OPTION : HIGH(3.3V) → Normal , LOW(GND) & Default → Jeida

Parameter		Symbol	Value			Unit	Note
			Min	Typ	Max		
CMOS Interface	Input High Thres hold Voltage	V_{IH} (High)	2.5	-	3.3	V	
	Input Low Thres hold Voltage	V_{IL} (Low)	0	-	0.5	V	

5.2 LVDS Interface

- LVDS Receiver : Tcon (merged)

- Data Format (JEIDA)

Default LVDS Option : JEIDA

	LVDS pin	JEIDA
TxOUT/RxIN0	TxIN/RxOUT0	R2
	TxIN/RxOUT1	R3
	TxIN/RxOUT2	R4
	TxIN/RxOUT3	R5
	TxIN/RxOUT4	R6
	TxIN/RxOUT6	R7
	TxIN/RxOUT7	G2
TxOUT/RxIN1	TxIN/RxOUT8	G3
	TxIN/RxOUT9	G4
	TxIN/RxOUT12	G5
	TxIN/RxOUT13	G6
	TxIN/RxOUT14	G7
	TxIN/RxOUT15	B2
	TxIN/RxOUT18	B3
TxOUT/RxIN2	TxIN/RxOUT19	B4
	TxIN/RxOUT20	B5
	TxIN/RxOUT21	B6
	TxIN/RxOUT22	B7
	TxIN/RxOUT24	HSYNC
	TxIN/RxOUT25	VSYNC
	TxIN/RxOUT26	DEN
TxOUT/RxIN3	TxIN/RxOUT27	R0
	TxIN/RxOUT5	R1
	TxIN/RxOUT10	G0
	TxIN/RxOUT11	G1
	TxIN/RxOUT16	B0
	TxIN/RxOUT17	B1
	TxIN/RxOUT23	RESERVED

5.3 Input Signals, Basic Display Colors and Gray Scale of Each Color

COLOR	DISPLAY (8bit)	DATA SIGNAL																					GRAY SCALE LEVEL			
		RED							GREEN							BLUE										
		R0	R1	R2	R3	R4	R5	R6	R7	G0	G1	G2	G3	G4	G5	G6	G7	B0	B1	B2	B3	B4		B5	B6	B7
BASIC COLOR	BLACK	0	0	0	0	0	0	0	0	0	0	0	0	0	0	0	0	0	0	0	0	0	0	0	0	-
	BLUE	0	0	0	0	0	0	0	0	0	0	0	0	0	0	0	0	1	1	1	1	1	1	1	1	-
	GREEN	0	0	0	0	0	0	0	0	1	1	1	1	1	1	1	1	0	0	0	0	0	0	0	0	-
	CYAN	0	0	0	0	0	0	0	0	1	1	1	1	1	1	1	1	1	1	1	1	1	1	1	1	-
	RED	1	1	1	1	1	1	1	1	0	0	0	0	0	0	0	0	0	0	0	0	0	0	0	0	-
	MAGENTA	1	1	1	1	1	1	1	1	0	0	0	0	0	0	0	0	1	1	1	1	1	1	1	1	-
	YELLOW	1	1	1	1	1	1	1	1	1	1	1	1	1	1	1	1	0	0	0	0	0	0	0	0	-
	WHITE	1	1	1	1	1	1	1	1	1	1	1	1	1	1	1	1	1	1	1	1	1	1	1	1	-
GRAY SCALE OF RED	BLACK	0	0	0	0	0	0	0	0	0	0	0	0	0	0	0	0	0	0	0	0	0	0	0	R0	
	DARK ↑	1	0	0	0	0	0	0	0	0	0	0	0	0	0	0	0	0	0	0	0	0	0	0	R1	
		0	1	0	0	0	0	0	0	0	0	0	0	0	0	0	0	0	0	0	0	0	0	0	R2	
		:	:	:	:	:	:	:	:	:	:	:	:	:	:	:	:	:	:	:	:	:	:	:	R3~	
		:	:	:	:	:	:	:	:	:	:	:	:	:	:	:	:	:	:	:	:	:	:	:	R252	
	LIGHT ↓	1	0	1	1	1	1	1	1	0	0	0	0	0	0	0	0	0	0	0	0	0	0	0	R253	
		0	1	1	1	1	1	1	1	0	0	0	0	0	0	0	0	0	0	0	0	0	0	0	R254	
	RED	1	1	1	1	1	1	1	1	0	0	0	0	0	0	0	0	0	0	0	0	0	0	0	R255	
GRAY SCALE OF GREEN	BLACK	0	0	0	0	0	0	0	0	0	0	0	0	0	0	0	0	0	0	0	0	0	0	0	G0	
	DARK ↑	0	0	0	0	0	0	0	0	1	0	0	0	0	0	0	0	0	0	0	0	0	0	0	G1	
		0	0	0	0	0	0	0	0	0	1	0	0	0	0	0	0	0	0	0	0	0	0	0	G2	
		:	:	:	:	:	:	:	:	:	:	:	:	:	:	:	:	:	:	:	:	:	:	:	G3~	
		:	:	:	:	:	:	:	:	:	:	:	:	:	:	:	:	:	:	:	:	:	:	:	G252	
	LIGHT ↓	0	0	0	0	0	0	0	0	1	0	1	1	1	1	1	1	0	0	0	0	0	0	0	G253	
		0	0	0	0	0	0	0	0	0	1	1	1	1	1	1	1	0	0	0	0	0	0	0	G254	
	GREEN	0	0	0	0	0	0	0	0	1	1	1	1	1	1	1	1	0	0	0	0	0	0	0	G255	
GRAY SCALE OF BLUE	BLACK	0	0	0	0	0	0	0	0	0	0	0	0	0	0	0	0	0	0	0	0	0	0	0	B0	
	DARK ↑	0	0	0	0	0	0	0	0	0	0	0	0	0	0	0	0	1	0	0	0	0	0	0	B1	
		0	0	0	0	0	0	0	0	0	0	0	0	0	0	0	0	0	1	0	0	0	0	0	B2	
		:	:	:	:	:	:	:	:	:	:	:	:	:	:	:	:	:	:	:	:	:	:	:	B3~	
		:	:	:	:	:	:	:	:	:	:	:	:	:	:	:	:	:	:	:	:	:	:	:	B252	
	LIGHT ↓	0	0	0	0	0	0	0	0	0	0	0	0	0	0	0	0	1	0	1	1	1	1	1	B253	
		0	0	0	0	0	0	0	0	0	0	0	0	0	0	0	0	0	1	1	1	1	1	1	B254	
	BLUE	0	0	0	0	0	0	0	0	0	0	0	0	0	0	0	0	1	1	1	1	1	1	1	B255	

Note)

(1) Definition of Gray : Rn : Red Gray, Gn : Green Gray, Bn : Blue Gray (n = Gray level)
 Input Signal : 0 = Low level voltage, 1 = High level voltage

6. Interface Timing

6.1 Timing Parameters (DE only mode)

SIGNAL	ITEM	SYMBOL	MIN.	TYP.	MAX.	UNIT	NOTE
Clock	Frequency	1/TC	72	78	85	MHz	-
Hsync		Fh	44	48	53	KHz	-
Vsync		Fv	48	60	66	Hz	-
Vertical Active Display Term	Display Period	TVD		768		lines	-
	Vertical Total	TV	776	802	1200	lines	-
Horizontal Active Display Term	Display Period	THD		1366		clocks	-
	Horizontal Total	TH	1480	1624	2000	clocks	-

Note) This product is DE mode. Required input option : Hsync, Vsync

6.2 Timing diagrams of interface signal (DE only mode)

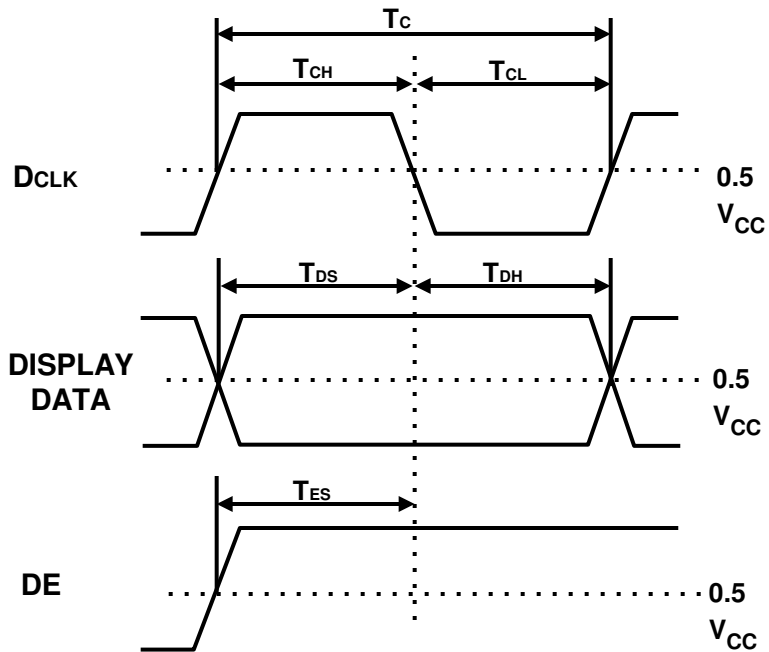
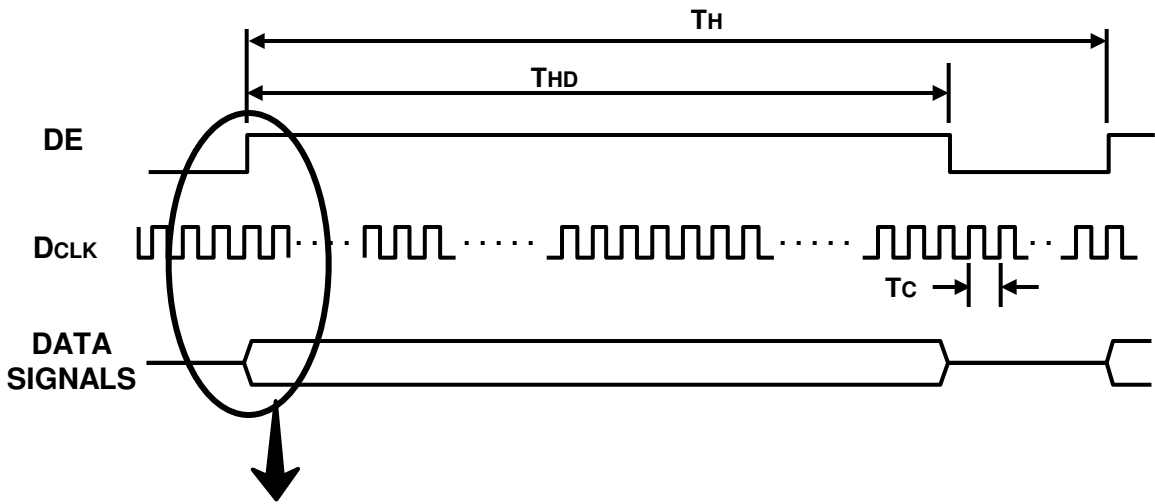
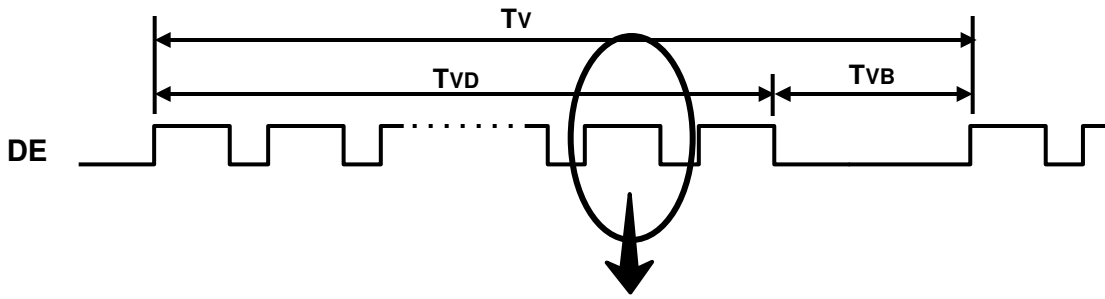

6.3 Power ON/OFF Sequence

To prevent a latch-up or DC operation of the LCD Module, the power on/off sequence should be as the diagram below.

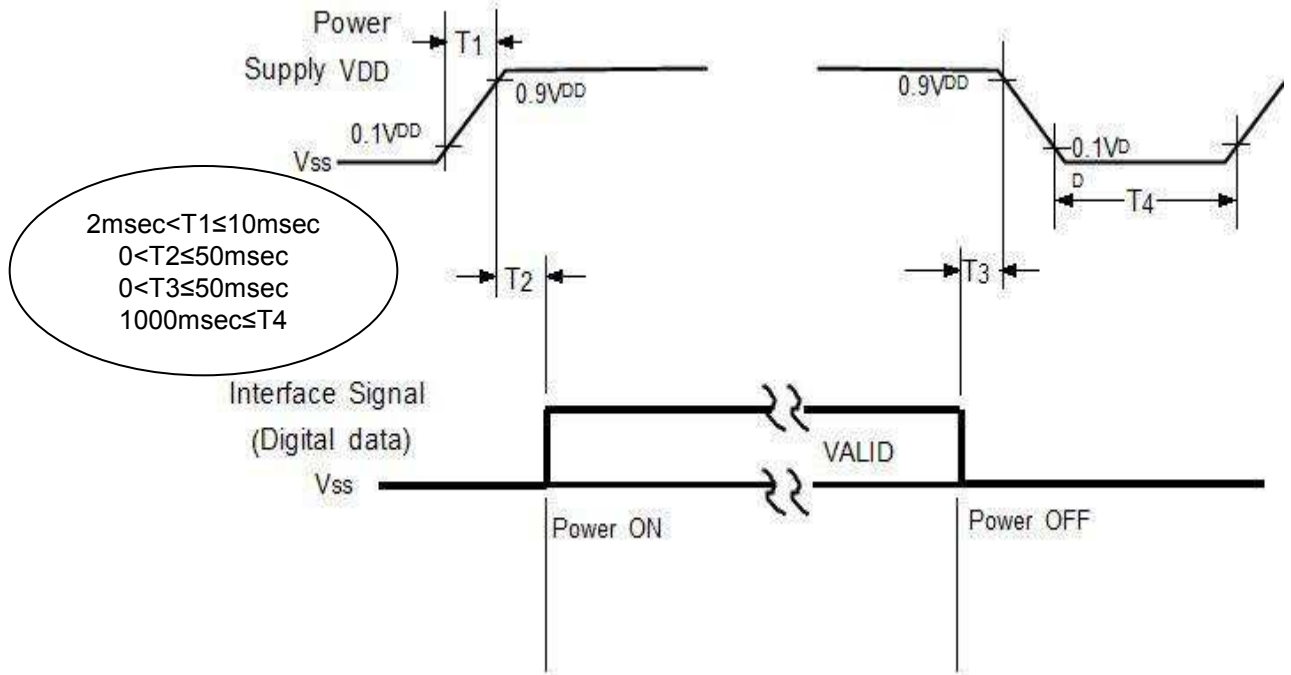

- T₁ : V_{DD} rising time from 10% to 90%
- T₂ : The time from V_{DD} to valid data at power ON.
- T₃ : The time from valid data off to V_{DD} off at power Off.
- T₄ : V_{DD} off time for Windows restart

- The supply voltage of the external system for the Module input should be the same as the definition of V_{DD}.
- Apply the lamp voltage within the LCD operation range. When the back light turns on before the LCD operation or the LCD turns off before the back light turns off, the display may momentarily show abnormal screen.
- In case of V_{DD} = off level, please keep the level of input signals low or keep a high impedance.
- T₄ should be measured after the Module has been fully discharged between power off and on period.
- Interface signal should not be kept at high impedance when the power is on.

7. Outline Dimension

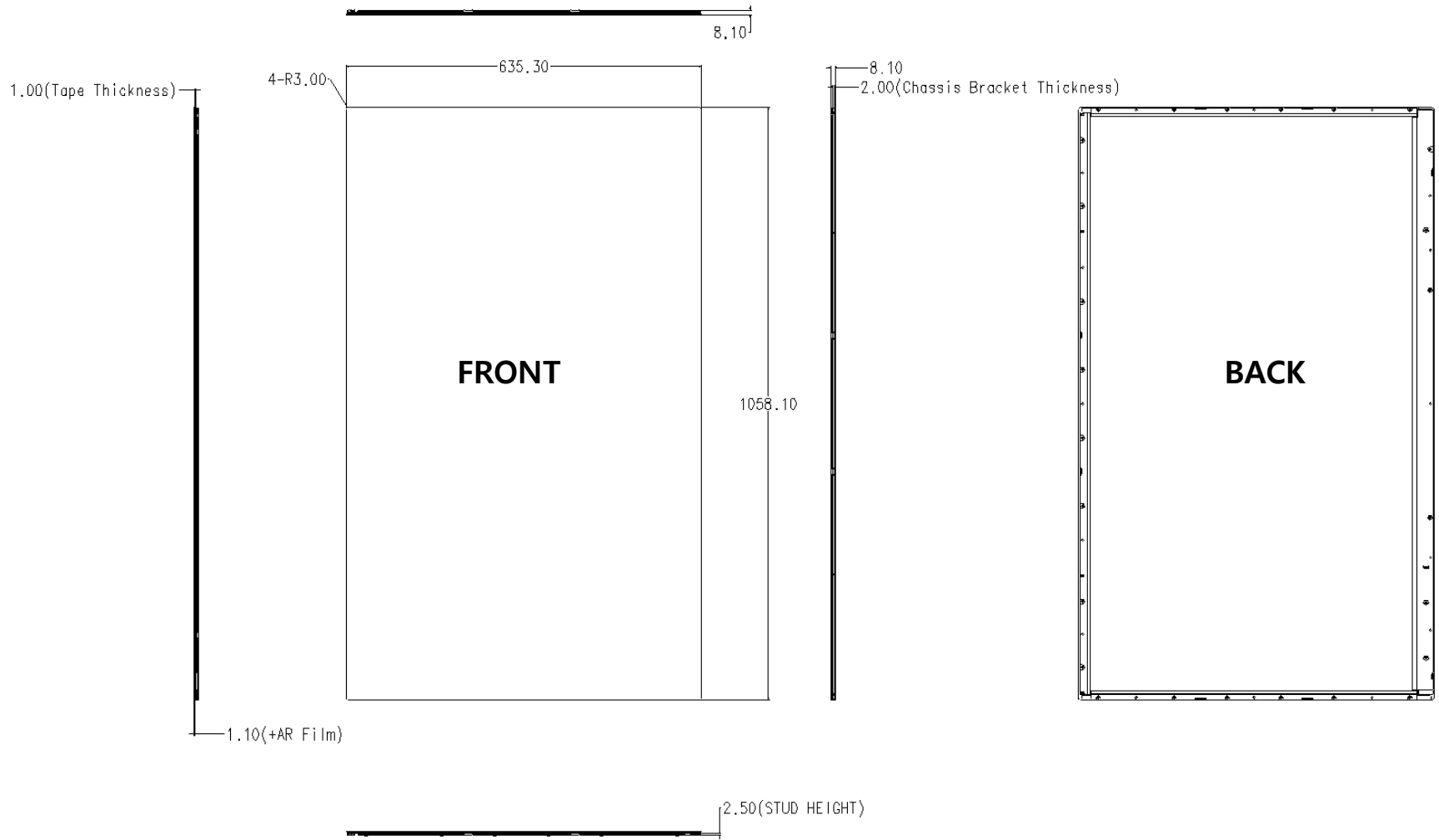

Model	LTI460AP01	Doc. No	05-000-G-110426	Page	18/24
-------	------------	---------	-----------------	------	-------

8. PACKING

8.1 CARTON (Internal Package)

(1) Packing Form

Corrugated fiberboard box and corrugated cardboard as shock absorber

(2) Packing Method

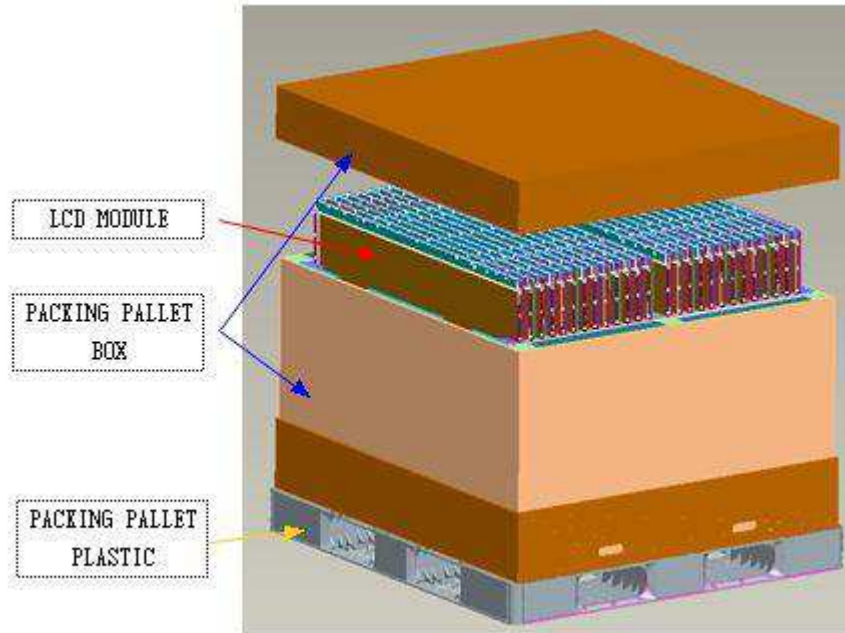

8.2 Packing Specification

ITEM	Specification	Remark
LCD Packing	26ea / Box (Packing-Pallet Box)	1. 5 Kg / LCD (26ea) 2. TBD Kg / Protector body (1ea) 3. TBD Kg / Packing-Pallet Box(Bottom/ top) (1ea) 5. Packing-Pallet Box Material : DW, TW
Pallet-Plastic	1Box / Pallet (PE,W1150,L985,H125,BLUE)	1. Pallet weight = 8kg 2. 8 Kg / Pallet
Packing Direction	Vertical	
Pallet size	H x V x height	1245mm(H) x 1130mm(V) x 677mm(height)
Pallet weight	140kg	Pallet (8kg) + Protector body(10kg) + Module (115kg) + Packing-Pallet Box (7kg)

8.3 Packing Storage condition

ITEM	Unit	Min.	Max.
Storage Temperature	(°C)	5	40
Storage Humidity	(%rH)	35	75
Storage life	12 months		
Storage Condition	<ul style="list-style-type: none"> - . Prohibit direct sunlight - . Ventilation in storehouse and Control changing temperature is within limits of environment - . Put it on pallet, don't put it on floor. and store them with removing from wall. - . Don't wet Out-BOX and avoid rain. - . Without condensation. - . Etc. Avoid harmful Condition. 		

8.4 Packing long-term Storage guide

Long –term Storage Process	More than 3months Storage or Low temp. Delivery/under 5°C Storage, → On the 20°C 50%rH Condition , More than 24hr release.
----------------------------	---

9. MARKING & OTHERS

A nameplate bearing followed by is affixed to a shipped product at the specified location on each product.

- (1) Part number : LTI460AP01
- (2) Revision: One letters
- (3) Lot number : X X X X XXX XX X

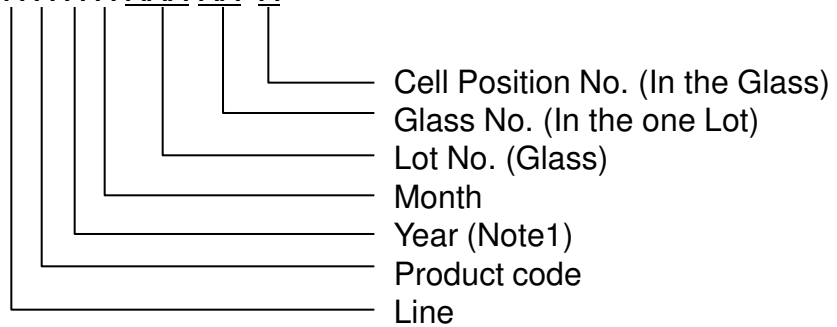

(4) Nameplate Indication

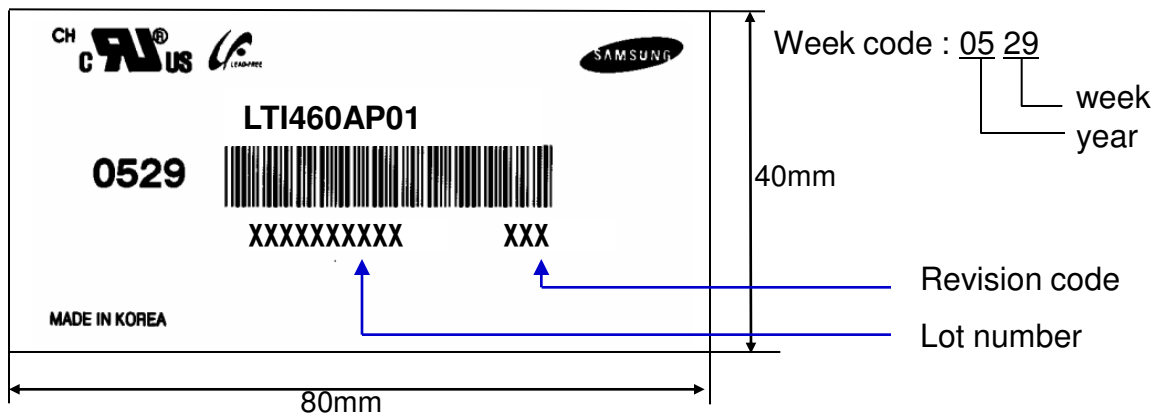

(5) Packing box attach

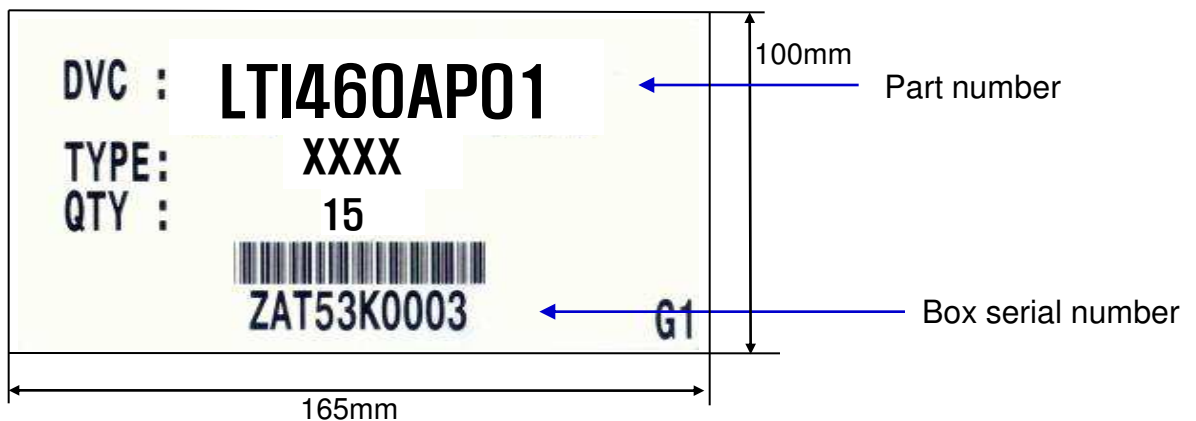

(6) Others

- 1. After service part

Lamps cannot be replaced because of the narrow bezel structure.

10. General Precautions

10.1 Handling

- (a) When the module is assembled, It should be attached to the system firmly using every mounting holes. Be careful not to twist and bend the modules.
- (b) Refrain from strong mechanical shock and / or any force to the module. In addition to damage, this may cause improper operation or damage to the module and back-light.
- (c) Note that polarizers are very fragile and could be easily damaged.
Do not press or scratch the surface harder than a HB pencil lead.
- (d) Wipe off water droplets or oil immediately. If you leave the droplets for a long time, Staining and discoloration may occur.
- (e) If the surface of the polarizer is dirty, clean it using some absorbent cotton or soft cloth.
- (f) The desirable cleaners are water, IPA(Isopropyl Alcohol) or Hexane.
Do not use Ketone type materials(ex. Acetone), Ethyl alcohol, Toluene, Ethyl acid or Methyl chloride.
It might permanent damage to the polarizer due to chemical reaction.
- (g) If the liquid crystal material leaks from the panel, it should be kept away from the eyes or mouth
In case of contact with hands, legs or clothes, it must be washed away thoroughly with soap.
- (h) Protect the module from static , it may cause damage to the CMOS Gate Array IC.
- (i) Use finger-stalls with soft gloves in order to keep display clean during the incoming inspection and assembly process.
- (j) Do not disassemble the module.
- (k) Do not adjust the variable resistor which is located on the module.
- (l) Protection film for polarizer on the module shall be slowly peeled off just before use so that the electrostatic charge can be minimized.

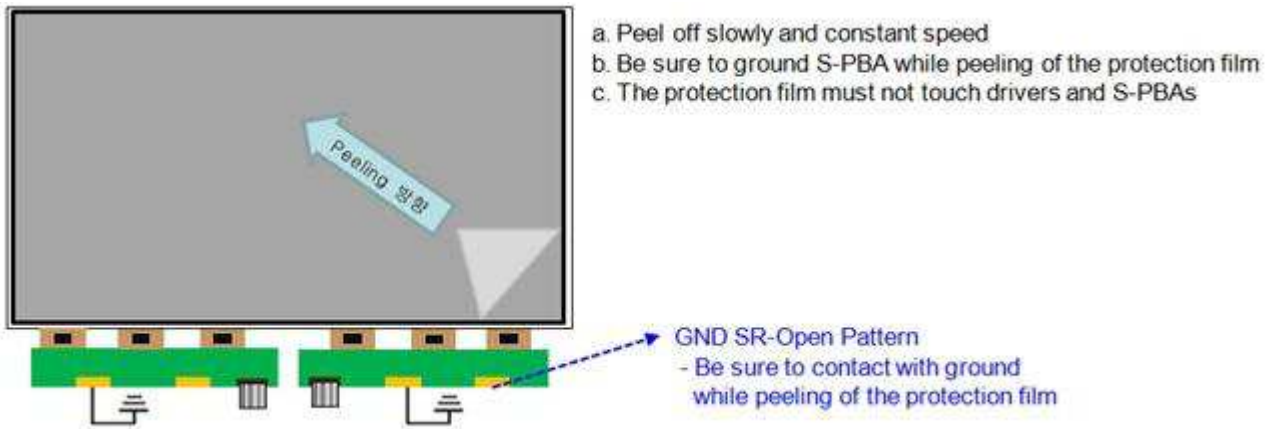

10.2 Storage

- (a) Do not leave the Module in high temperature, and high humidity for a long time. It is highly recommended to store the Module with temperature from 0 to 35°C and relative humidity of less than 70%.
- (b) Do not store the TFT-LCD Module in direct sunlight.
- (c) The Module should be stored in a dark place. It is prohibited to apply sunlight or fluorescent light in storing.

10.3 Operation

- (a) Do not connect or disconnect the Module in the "Power On" condition.
- (b) Power supply should always be turned on/off by the "Power on/off sequence"
- (c) Module has high frequency circuits. Sufficient suppression to the electromagnetic interference should be done by system manufacturers.
 Grounding and shielding methods may be important to minimize the interference.

10.4 Others

- (a) Ultra-violet ray filter is necessary for outdoor operation.
- (b) Avoid condensation of water. It may result in improper operation or disconnection of electrode.
- (c) Do not exceed the absolute maximum rating value. (the supply voltage variation, Input voltage variation, variation in part contents and environmental temperature, and so on) Otherwise the module may be damaged.
- (d) If the module displays the same pattern continuously for a long period of time, it can be the situation when the image "Sticks" to the screen.
- (e) This module has its circuitry PCB's on the rear side and should be handled carefully in order not to be stressed.