

**PRELIMINARY**

**NLT Technologies, Ltd.**

# **TFT COLOR LCD MODULE**

**NL8048BC24-12D**

**23cm (9.0 Type)**

**WVGA**

**LVDS interface (1port)**

**PRELIMINARY DATA SHEET** 

**DOD-PP-1309 (1st edition)**

**All information is subject to change without notice.  
Please confirm the sales representative before  
starting to design your system.**

# PRELIMINARY

## INTRODUCTION

The Copyright to this document belongs to NLT Technologies, Ltd. (hereinafter called "NLT"). No part of this document will be used, reproduced or copied without prior written consent of NLT.

NLT does and will not assume any liability for infringement of patents, copyrights or other intellectual property rights of any third party arising out of or in connection with application of the products described herein except for that directly attributable to mechanisms and workmanship thereof. No license, express or implied, is granted under any patent, copyright or other intellectual property right of NLT.

Some electronic parts/components would fail or malfunction at a certain rate. In spite of every effort to enhance reliability of products by NLT, the possibility of failures and malfunction might not be avoided entirely. To prevent the risks of damage to death, human bodily injury or other property arising out thereof or in connection therewith, each customer is required to take sufficient measures in its safety designs and plans including, but not limited to, redundant system, fire-containment and anti-failure.

The products are classified into three quality grades: "**Standard**", "**Special**", and "**Specific**" of the highest grade of a quality assurance program at the choice of a customer. Each quality grade is designed for applications described below. Any customer who intends to use a product for application other than that of Standard quality grade is required to contact an NLT sales representative in advance.

The **Standard** quality grade applies to the products developed, designed and manufactured in accordance with the NLT standard quality assurance program, which are designed for such application as any failure or malfunction of the products (sets) or parts/components incorporated therein a customer uses are, directly or indirectly, free of any damage to death, human bodily injury or other property, like general electronic devices.

Examples: Computers, office automation equipment, communications equipment, test and measurement equipment, audio and visual equipment, home electronic appliances, machine tools, personal electronic equipment, industrial robots, etc.

The **Special** quality grade applies to the products developed, designed and manufactured in accordance with an NLT quality assurance program stricter than the standard one, which are designed for such application as any failure or malfunction of the products (sets) or parts/components incorporated therein a customer uses might directly cause any damage to death, human bodily injury or other property, or such application under more severe condition than that defined in the Standard quality grade without such direct damage.

Examples: Control systems for transportation equipment (automobiles, trains, ships, etc.), traffic control systems, anti-disaster systems, anti-crime systems, medical equipment not specifically designed for life support, safety equipment, etc.

The **Specific** quality grade applies to the products developed, designed and manufactured in accordance with the standards or quality assurance program designated by a customer who requires an extremely higher level of reliability and quality for such products.

Examples: Military systems, aircraft control equipment, aerospace equipment, nuclear reactor control systems, medical equipment/devices/systems for life support, etc.

The quality grade of this product is the "**Standard**" unless otherwise specified in this document.

# PRELIMINARY

## CONTENTS

<b>INTRODUCTION .....</b>	<b>2</b>
<b>1. OUTLINE.....</b>	<b>4</b>
1.1 STRUCTURE AND PRINCIPLE .....	4
1.2 APPLICATION .....	4
1.3 FEATURES .....	4
<b>2. GENERAL SPECIFICATIONS.....</b>	<b>5</b>
<b>3. BLOCK DIAGRAM.....</b>	<b>6</b>
<b>4. DETAILED SPECIFICATIONS.....</b>	<b>8</b>
4.1 MECHANICAL SPECIFICATIONS .....	8
4.2 ABSOLUTE MAXIMUM RATINGS.....	8
4.3 ELECTRICAL CHARACTERISTICS.....	9
4.3.1 LCD panel signal processing board .....	9
4.3.2 Backlight lamp .....	10
4.3.3 Power supply voltage ripple.....	10
4.3.4 Fuse.....	10
4.4 POWER SUPPLY VOLTAGE SEQUENCE .....	11
4.4.1 LCD panel signal processing board .....	11
4.4.2 LED driver board .....	11
4.5 CONNECTIONS AND FUNCTIONS FOR INTERFACE PINS .....	12
4.5.1 LCD panel signal processing board .....	12
4.5.2 Backlight lamp .....	13
4.5.3 Positions of plugs and a socket.....	13
4.5.4 Connection between receiver and transmitter for LVDS .....	14
4.6 DISPLAY COLORS AND INPUT DATA SIGNALS.....	16
4.6.1 Combinations of input data signals and FRC signal .....	16
4.6.2 16,777,216 colors.....	17
4.6.3 262,144 colors.....	18
4.7 DISPLAY POSITIONS .....	19
4.8 SCANNING DIRECTIONS .....	19
4.9 INPUT SIGNAL TIMINGS .....	20
4.9.1 Outline of input signal timings .....	20
4.9.2 Timing characteristics.....	21
4.9.3 Input signal timing chart.....	22
4.10 OPTICS.....	23
4.10.1 Optical characteristics .....	23
4.10.2 Definition of contrast ratio.....	24
4.10.3 Definition of luminance uniformity .....	24
4.10.4 Definition of response times .....	24
4.10.5 Definition of viewing angles.....	24
<b>5. ESTIMATED LUMINANCE LIFETIME.....</b>	<b>25</b>
<b>6. RELIABILITY TESTS .....</b>	<b>26</b>
<b>7. PRECAUTIONS .....</b>	<b>27</b>
7.1 MEANING OF CAUTION SIGNS .....	27
7.2 CAUTIONS .....	27
7.3 ATTENTIONS.....	27
7.3.1 Handling of the product .....	27
7.3.2 Environment.....	28
7.3.3 Characteristics.....	28
7.3.4 Others.....	28
<b>8. OUTLINE DRAWINGS.....</b>	<b>29</b>
8.1 FRONT VIEW .....	29
8.2 REAR VIEW .....	30
<b>REVISION HISTORY .....</b>	<b>31</b>

### 1. OUTLINE

#### 1.1 STRUCTURE AND PRINCIPLE

Color LCD module NL8048BC24-12D is composed of the amorphous silicon thin film transistor liquid crystal display (a-Si TFT LCD) panel structure with driver LSIs for driving the TFT (Thin Film Transistor) array and a backlight.

The a-Si TFT LCD panel structure is injected liquid crystal material into a narrow gap between the TFT array glass substrate and a color-filter glass substrate.

Color (Red, Green, Blue) data signals from a host system (e.g. signal generator, etc.) are modulated into best form for active matrix system by a signal processing circuit, and sent to the driver LSIs which drive the individual TFT arrays.

The TFT array as an electro-optical switch regulates the amount of transmitted light from the backlight assembly, when it is controlled by data signals. Color images are created by regulating the amount of transmitted light through the TFT array of red, green and blue dots.

#### 1.2 APPLICATION

- For industrial use

#### 1.3 FEATURES

- Long life LED backlight type
- High luminance
- High contrast
- Wide viewing angle
- Wide temperature range
- LVDS interface
- Reversible-scan direction
- Selectable 8bit or 6bit digital signals for data of RGB
- Replaceable lamp for backlight

# PRELIMINARY

## 2. GENERAL SPECIFICATIONS

<b>Display area</b>	196.8 (H) × 118.08 (V) mm
<b>Diagonal size of display</b>	23cm (9.0 inches)
<b>Drive system</b>	a-Si TFT active matrix
<b>Display color</b>	16,777,216 colors (At 8-bit input, FRC terminal= High) 262,144 colors (At 6-bit input, FRC terminal= Low or Open)
<b>Pixel</b>	800 (H) × 480 (V) pixels
<b>Pixel arrangement</b>	RGB (Red dot, Green dot, Blue dot) vertical stripe
<b>Dot pitch</b>	0.082 (H) × 0.246 (V) mm
<b>Pixel pitch</b>	0.246 (H) × 0.246 (V) mm
<b>Module size</b>	220.5 (W) × 136.5 (H) × 8.2 (D) mm (typ.)
<b>Weight</b>	(275) g (typ.)
<b>Contrast ratio</b>	(600: 1) (typ.)
<b>Viewing angle</b>	At the contrast ratio $\geq 10:1$ <ul style="list-style-type: none"> <li>• Horizontal: Right side 80° (typ.), Left side 80° (typ.)</li> <li>• Vertical: Up side 80° (typ.), Down side (80)° (typ.)</li> </ul>
<b>Designed viewing direction</b>	At DPS= Low or open: Normal scan <ul style="list-style-type: none"> <li>• Viewing direction without image reversal: Up side (12 o'clock)</li> <li>• Viewing direction with contrast peak: Down side (6 o'clock)</li> <li>• Viewing angle with optimum grayscale (<math>\gamma \approx 2.2</math>): Normal axis (perpendicular)</li> </ul>
<b>Polarizer surface</b>	Antiglare
<b>Polarizer pencil-hardness</b>	3H (min.) [by JIS K5600]
<b>Color gamut</b>	At LCD panel center 60 % (typ.) [against NTSC color space]
<b>Response time</b>	$T_{on} + T_{off}$ (10% ← → 90%) (25) ms (typ.)
<b>Luminance</b>	At $I_L = (50) mA / One\ circuit$ (500) $cd/m^2$ (typ.)
<b>Signal system</b>	LVDS 1port (Receiver: THC63LVDF84B, THine Electronics Inc. or equivalent) [8bit/6bit digital signals for data of RGB colors, Dot clock (CLK), Data enable (DE)]
<b>Power supply voltage</b>	LCD panel signal processing board: 3.3V
<b>Backlight</b>	LED backlight type: <div style="display: flex; align-items: center; margin-top: 10px;"> <div style="font-size: 2em; margin-right: 10px;">{</div> <div style="margin-right: 10px;">Replaceable part</div> <div style="font-size: 2em; margin-right: 10px;">}</div> </div> <ul style="list-style-type: none"> <li>• Lamp holder set: Type No.90LHS05</li> </ul> <div style="display: flex; align-items: center; margin-top: 10px;"> <div style="font-size: 2em; margin-right: 10px;">{</div> <div style="margin-right: 10px;">Recommended LED driver board (Option)</div> <div style="font-size: 2em; margin-right: 10px;">}</div> </div> <ul style="list-style-type: none"> <li>• LED driver board: Type No. (104PW03F)</li> <li>• Corresponding wiring harness: Type No. 121CBL02</li> </ul>
<b>Power consumption</b>	At $I_L = (50) mA / One\ circuit$ , Checkered flag pattern (4.3) W (typ.)

**3. BLOCK DIAGRAM**

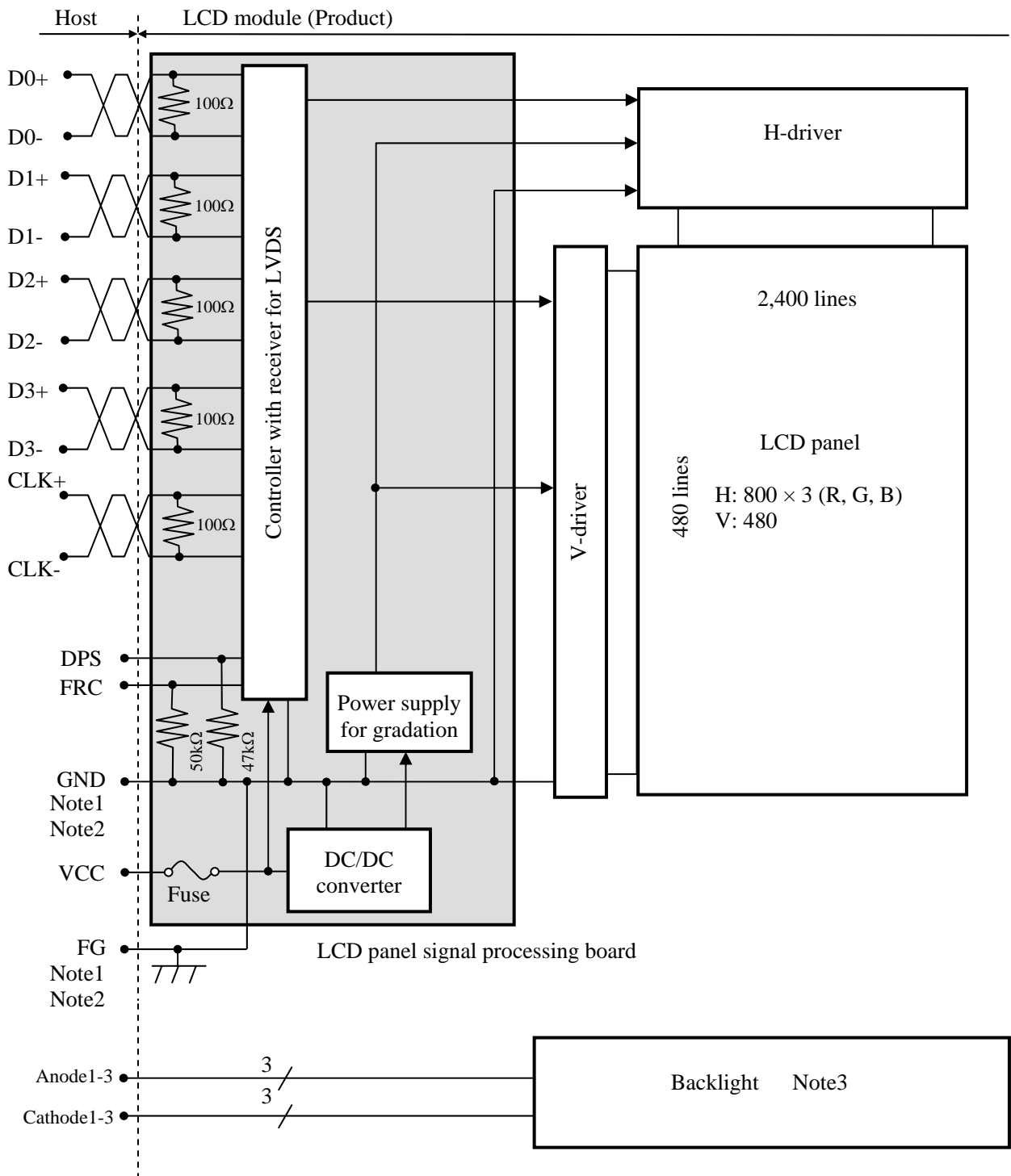

Note1: Relations between GND (Signal ground) and FG (Frame ground) in the LCD module are as follows.

GND - FG	Connected
----------	-----------

Note2: GND and FG must be connected to customer equipment's ground, and it is recommended that these grounds be connected together in customer equipment.

# PRELIMINARY

NLT Technologies, Ltd.

NL8048BC24-12D

Note3: Backlight in detail

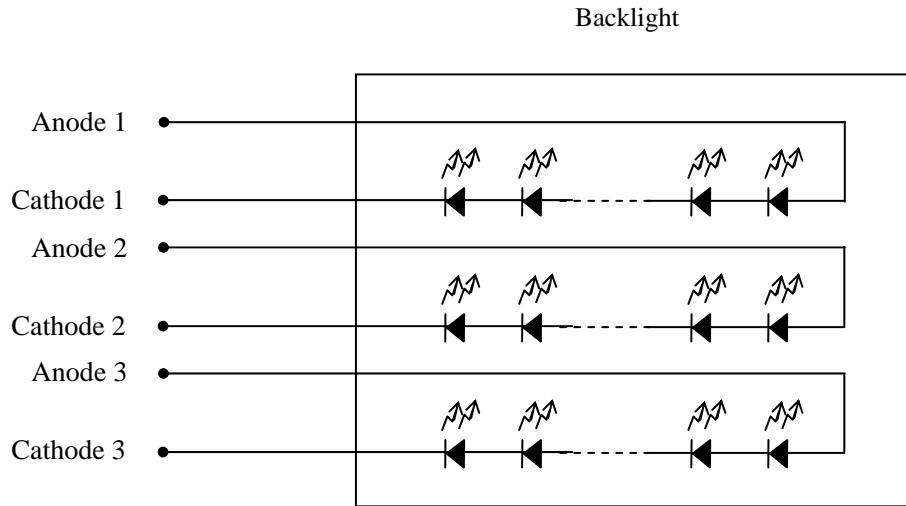

# PRELIMINARY

## 4. DETAILED SPECIFICATIONS

### 4.1 MECHANICAL SPECIFICATIONS

Parameter	Specification	Unit
Module size	220.5 ± 0.5 (W) × 136.5 ± 0.5 (H) × 8.2 ± 0.5 (D) Note1	mm
Display area	196.8 (H) × 118.08 (V) Note1	mm
Weight	(275) (typ.), (290) (max.)	g

Note1: See "8. OUTLINE DRAWINGS".

### 4.2 ABSOLUTE MAXIMUM RATINGS

Parameter		Symbol	Rating	Unit	Remarks
Power supply voltage	LCD panel signal processing board	VCC	-0.3 to +4.0	V	-
Input voltage for signals	Display signals Note1	VD	-0.3 to VCC+0.3	V	
	Function signals Note2	VF			
Backlight	Forward current	IL	(60)	mA	per one circuit
Storage temperature		Tst	-30 to +80	°C	-
Operating temperature	Front surface	TopF	-20 to +70	°C	Note3
	Rear surface	TopR	-20 to +70	°C	Note4
Relative humidity Note5		RH	≤ 95	%	Ta ≤ 40°C
			≤ 85	%	40°C < Ta ≤ 50°C
			≤ 55	%	50°C < Ta ≤ 60°C
			≤ 36	%	60°C < Ta ≤ 70°C
Absolute humidity Note5		AH	≤ 70 Note6	g/m <sup>3</sup>	Ta > 70°C

Note1: D0+/-, D1+/-, D2+/-, D3+/- and CLK+/-

Note2: DPS, FRC

Note3: Measured at center of LCD panel surface (including self-heat)

Note4: Measured at center of LCD module's rear shield surface (including self-heat)

Note5: No condensation

Note6: Water amount at Ta= 70°C and RH= 36%



# PRELIMINARY

## 4.3 ELECTRICAL CHARACTERISTICS

### 4.3.1 LCD panel signal processing board

(Ta= 25°C)

Parameter	Symbol	min.	typ.	max.	Unit	Remarks	
Power supply voltage	VCC	3.0	3.3	3.6	V	-	
Power supply current	ICC	-	(340) Note1	(450) Note2	mA	at VCC= 3.3V	
Permissible ripple voltage	VRP	-	-	100	mVp-p	for VCC	
Differential input threshold voltage	High	VTH	-	-	+100	mV	at VCM= 1.2V Note3
	Low	VTL	-100	-	-	mV	
Terminating resistance	RT	-	100	-	Ω	-	
Input voltage for DPS, FRC signals	High	VFH	0.7VCC	-	VCC	V	CMOS level
	Low	VFL	0	-	0.3VCC	V	
Input current for DPS, FRC signals	High	IFH	-	-	300	μA	-
	Low	IFL	-300	-	-	μA	

Note1: Checkered flag pattern [by EIAJ ED-2522]

Note2: Pattern for maximum current

Note3: Common mode voltage for LVDS receiver

# PRELIMINARY

### 4.3.2 Backlight lamp

(Ta= 25°C, Note1, Note2 Note3)

Parameter	Symbol	min.	typ.	max.	Unit	Remarks
Forward current	IL	-	(50.0)	(55.0)	mA	-
Forward Voltage	VL	(18.5)	(21.0)	(23.8)	V	Ta= +25°C at IL= (50)mA /One circuit
		(16.8)	-	-		Ta= +70°C at IL= (50)mA /One circuit
		-	-	(25.7)		Ta= -20°C at IL= (50)mA /One circuit
		-	-	(25.9)		Ta= -20°C at IL= (55)mA /One circuit

Note1: Please drive with constant current.

Note2: The above specifications are for one LED circuit of the backlight.

Note3: The Luminance uniformity may be changed depending on the current variation between 3 circuits. It is recommended that the current value difference among the circuits be less than 5%.

### 4.3.3 Power supply voltage ripple

This product works if the ripple voltage levels are over the permissible values as the following table, but there might be noise on the display image.

Power supply voltage	Ripple voltage (Measure at input terminal of power supply)	Unit
VCC	3.3V	≤ 100 mVp-p

Note1: The permissible ripple voltage includes spike noise.

### 4.3.4 Fuse

Parameter	Fuse		Rating	Fusing current	Remarks
	Type	Supplier			
VCC	FCC16162AB	KAMAYA ELECTRIC Co., Ltd.	1.6A	3.2A	Note1
			36V		

Note1: The power supply's rated current must be more than the fusing current. If it is less than the fusing current, the fuse may not blow in a short time, and then nasty smell, smoke and so on may occur.

### 4.4 POWER SUPPLY VOLTAGE SEQUENCE

#### 4.4.1 LCD panel signal processing board

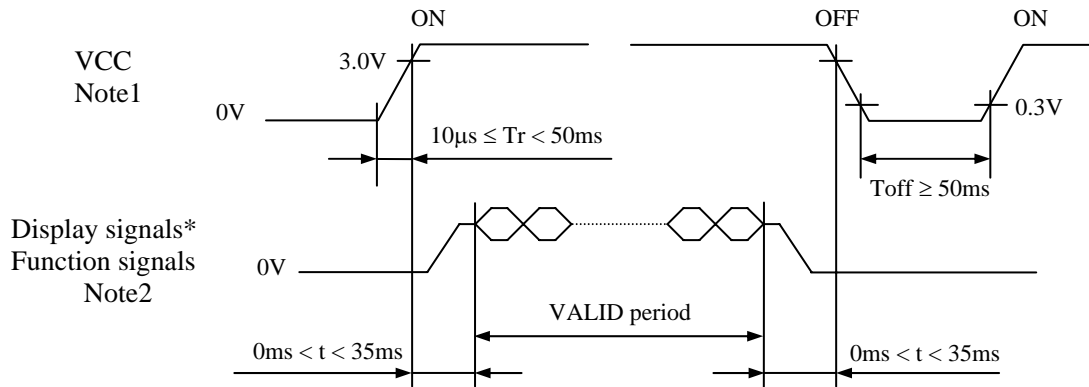

\* These signals should be measured at the terminal of 100Ω resistance.

Note1: If there is a voltage variation (voltage drop) at the rising edge of VCC below 3.0V, there is a possibility that a product does not work due to a protection circuit.

Note2: Display signals (D0+/-, D1+/-, D2+/-, D3+/- and CLK+/-) and function signals (DPS and FRC) must be set to Low or High-impedance, except the VALID period (See above sequence diagram), in order to avoid the circuitry damage.

If some of display and function signals of this product are cut while this product is working, even if the signal input to it once again, it might not work normally. If a customer stops the display and function signals, VCC also must be shut down.

#### 4.4.2 LED driver board

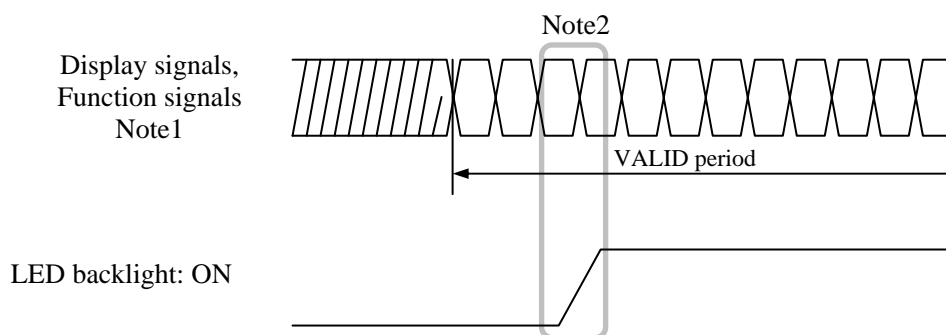

Note1: These are the display and function signals for LCD panel signal processing board.

Note2: The backlight should be turned on within the valid period of display and function signals, in order to avoid unstable data display.

# PRELIMINARY

## 4.5 CONNECTIONS AND FUNCTIONS FOR INTERFACE PINS

### 4.5.1 LCD panel signal processing board

CN1 socket (LCD module side): FI-SE20P-HFE (Japan Aviation Electronics Industry Limited (JAE))  
 Adaptable plug: FI-S20S (Japan Aviation Electronics Industry Limited (JAE))

Pin No.	Symbol	Signal	Remarks
1	A	D3+	Pixel data Note1, Note3
	B	GND	Ground Note4
2	A	D3-	Pixel data Note1, Note3
	B	GND	Ground Note4
3	DPS	Selection of scan direction	High: Reverse scan Low or Open: Normal scan Note2
4	FRC	Selection of the number of colors	High: 16,777,216 colors Low or Open: 262,144 colors Note1
5	GND	Ground	Note4
6	CLK+	Pixel clock	Note3
7	CLK-		
8	GND	Ground	Note4
9	D2+	Pixel data	Note3
10	D2-		
11	GND	Ground	Note4
12	D1+	Pixel data	Note3
13	D1-		
14	GND	Ground	Note4
15	D0+	Pixel data	Note3
16	D0-		
17	GND	Ground	Note4
18	GND		
19	VCC	Power supply	Note4
20	VCC		

Note1: See "4.6 DISPLAY COLORS AND INPUT DATA SIGNALS".

Note2: See "4.8 SCANNING DIRECTIONS".

Note3: Twist pair wires with 100Ω (Characteristic impedance) should be used between LCD panel signal processing board and LVDS transmitter.

Note4: All GND and VCC terminals should be used without any non-connected lines.

Note5: See "4.5.4 Connection between receiver and transmitter for LVDS".

# PRELIMINARY

### 4.5.2 Backlight lamp

CN2 plug (LCD module side): SM08B-SRSS-TB (J.S.T. Mfg. Co., Ltd.)

Adaptable socket: SHR-08V-S, SHR-08V-S-B (J.S.T. Mfg. Co., Ltd.)

Pin No.	Symbol	Signal	Remarks
1	A1	Anode1	-
2	K1	Cathode1	-
3	A2	Anode2	-
4	K2	Cathode2	-
5	A3.	Anode3	-
6	K3	Cathode3	-
7	N. C.	-	Keep this pin Open.
8	N. C.	-	Keep this pin Open.

### 4.5.3 Positions of plugs and a socket

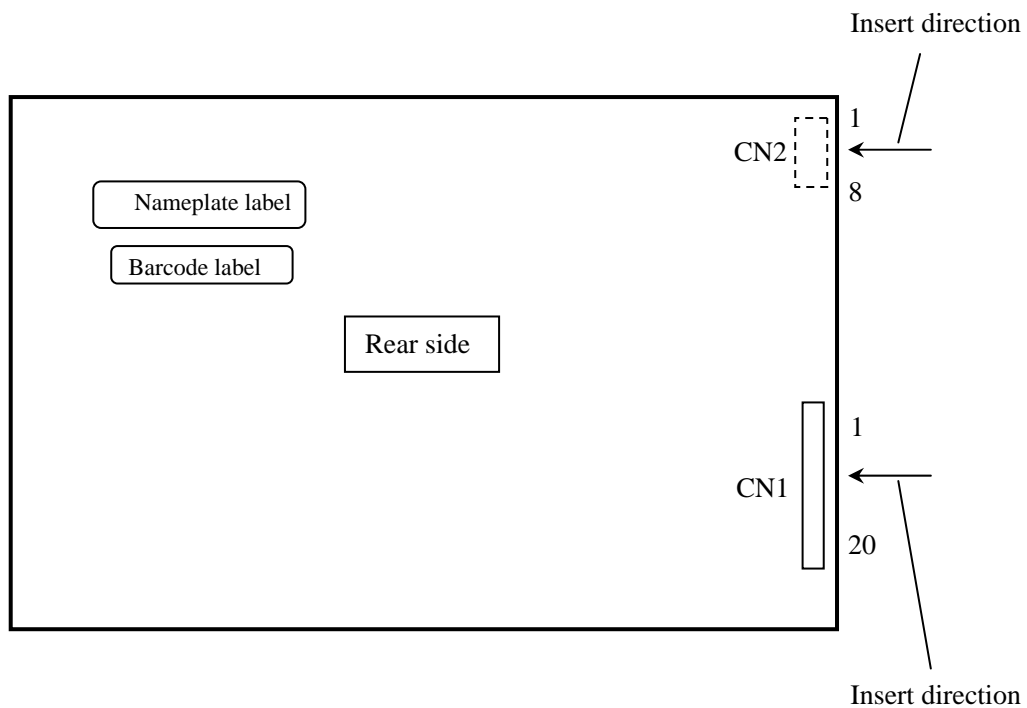

### 4.5.4 Connection between receiver and transmitter for LVDS

(1) Input data signal: 8bit

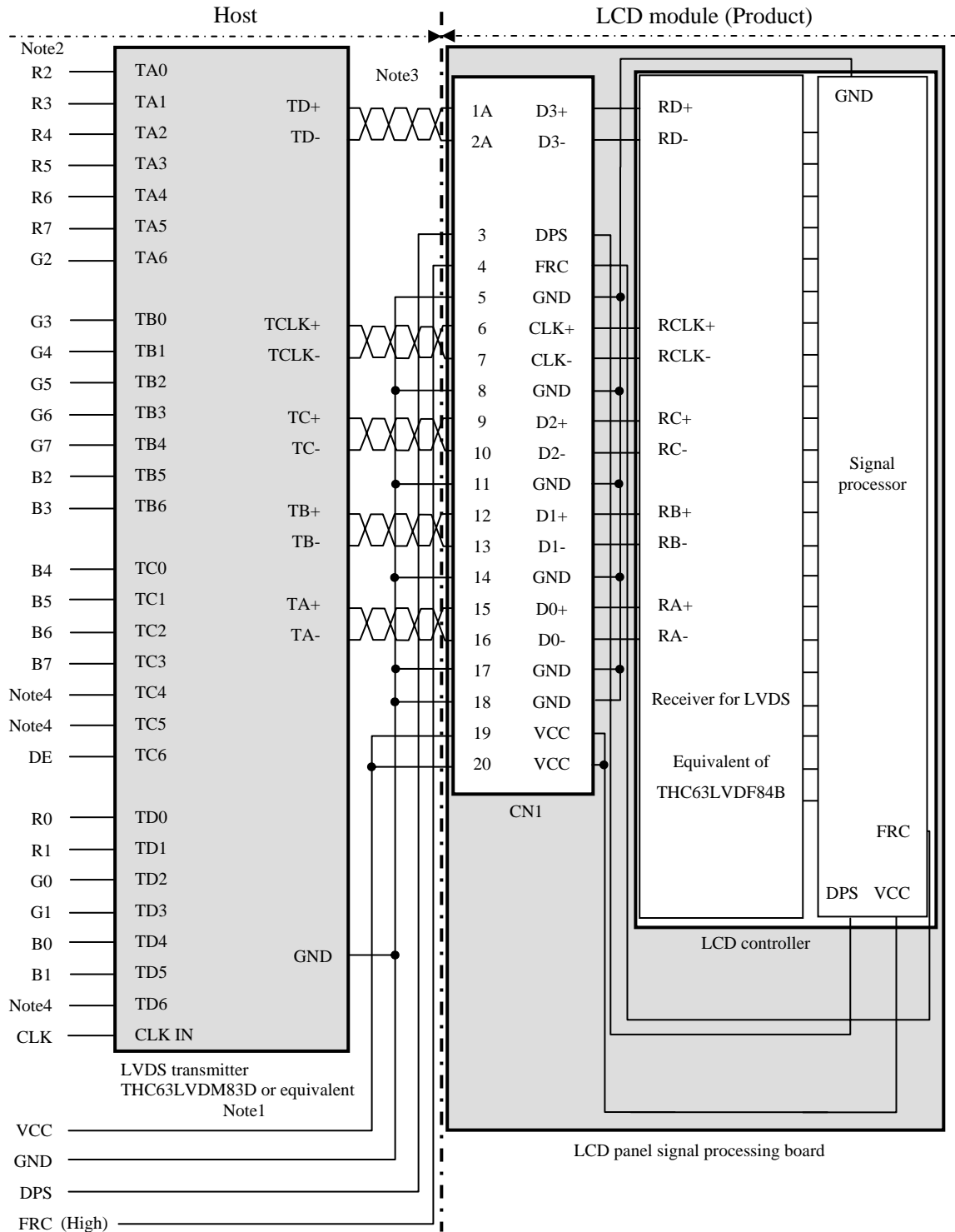

Note1: Recommended transmitter: THC63LVDM83D (THine Electronics Inc.) or equivalent

Note2: LSB (Least Significant Bit) – R0, G0, B0 MSB (Most Significant Bit) – R7, G7, B7

Note3: Twist pair wires with 100Ω (Characteristic impedance) should be used between LCD panel signal processing board and LVDS transmitter.

Note4: Input signals to TC4, TC5 and TD6 are not used inside the product, but do not keep TC4, TC5 and TD6 open to avoid noise problem.

# PRELIMINARY

(2) Input data signal: 6bit

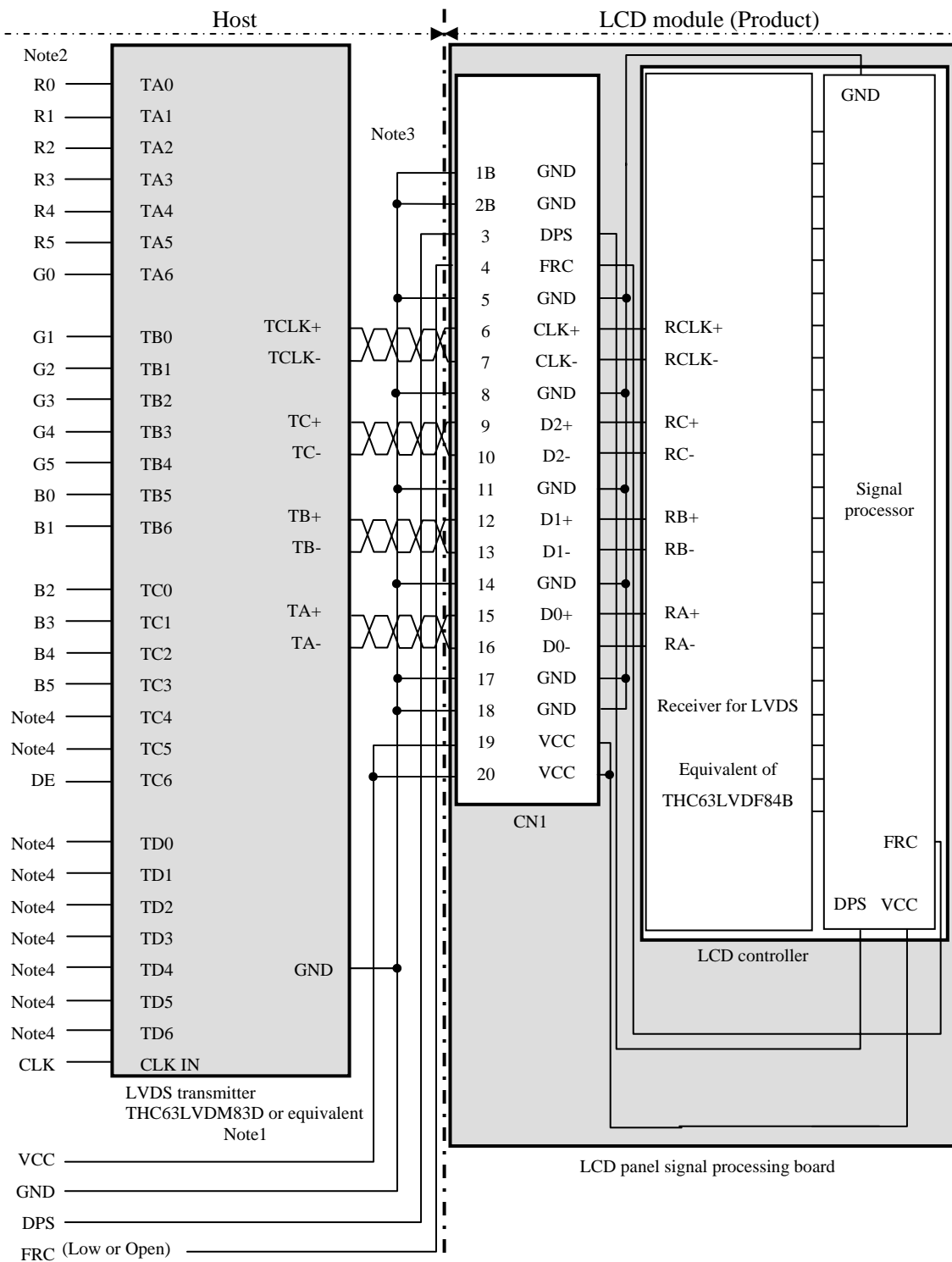

Note1: Recommended transmitter THC63LVDM83D (THine Electronics Inc.) or equivalent

Note2: LSB (Least Significant Bit) – R0, G0, B0 MSB (Most Significant Bit) – R5, G5, B5

Note3: Twist pair wires with 100Ω (Characteristic impedance) should be used between LCD panel signal processing board and LVDS transmitter.

Note4: Input signals to TC4, TC5 and TD0-6 are not used inside the product, but do not keep TC4, TC5 and TD0-6 open to avoid noise problem.

# PRELIMINARY

## 4.6 DISPLAY COLORS AND INPUT DATA SIGNALS

### 4.6.1 Combinations of input data signals and FRC signal

This product can display 16,777,216 colors equivalent with 256 gray scales and 262,144 colors with 64 gray scales by combination of input data signals and FRC signal. See the following table.

Combination	Input data signals	CN1-Pin No.1 and 2	FRC terminal	Display colors	Remarks
①	8 bit	D3+/-	High	16,777,216	Note1
②	6 bit	GND	Low or Open	262,144	Note2

Note1: See "**4.6.2 16,777,216 colors**".

Note2: See "**4.6.3 262,144 colors**".



# PRELIMINARY

4.6.2 16,777,216 colors

This product can display 16,777,216 colors equivalent with 256 gray scales by combination ①.  
 (See "4.6.1 Combinations of input data signals and FRC signal".)

Also the relation between display colors and input data signals is as follows.

Display colors		Data signal (0: Low level, 1: High level)																							
		R7	R6	R5	R4	R3	R2	R1	R0	G7	G6	G5	G4	G3	G2	G1	G0	B7	B6	B5	B4	B3	B2	B1	B0
Basic Colors	Black	0	0	0	0	0	0	0	0	0	0	0	0	0	0	0	0	0	0	0	0	0	0	0	0
	Blue	0	0	0	0	0	0	0	0	0	0	0	0	0	0	0	0	1	1	1	1	1	1	1	1
	Red	1	1	1	1	1	1	1	1	0	0	0	0	0	0	0	0	0	0	0	0	0	0	0	0
	Magenta	1	1	1	1	1	1	1	1	0	0	0	0	0	0	0	0	1	1	1	1	1	1	1	1
	Green	0	0	0	0	0	0	0	0	1	1	1	1	1	1	1	1	0	0	0	0	0	0	0	0
	Cyan	0	0	0	0	0	0	0	0	1	1	1	1	1	1	1	1	1	1	1	1	1	1	1	1
	Yellow	1	1	1	1	1	1	1	1	1	1	1	1	1	1	1	1	0	0	0	0	0	0	0	0
	White	1	1	1	1	1	1	1	1	1	1	1	1	1	1	1	1	1	1	1	1	1	1	1	1
Red gray scale	Black	0	0	0	0	0	0	0	0	0	0	0	0	0	0	0	0	0	0	0	0	0	0	0	0
	dark	0	0	0	0	0	0	0	1	0	0	0	0	0	0	0	0	0	0	0	0	0	0	0	0
	↑																								
	↓																								
	bright	1	1	1	1	1	1	0	1	0	0	0	0	0	0	0	0	0	0	0	0	0	0	0	0
	Red	1	1	1	1	1	1	1	1	0	0	0	0	0	0	0	0	0	0	0	0	0	0	0	0
Green gray scale	Black	0	0	0	0	0	0	0	0	0	0	0	0	0	0	0	0	0	0	0	0	0	0	0	0
	dark	0	0	0	0	0	0	0	0	0	0	0	0	0	0	0	1	0	0	0	0	0	0	0	0
	↑																								
	↓																								
	bright	0	0	0	0	0	0	0	0	1	1	1	1	1	1	0	1	0	0	0	0	0	0	0	0
	Green	0	0	0	0	0	0	0	0	1	1	1	1	1	1	1	1	0	0	0	0	0	0	0	0
Blue gray scale	Black	0	0	0	0	0	0	0	0	0	0	0	0	0	0	0	0	0	0	0	0	0	0	0	0
	dark	0	0	0	0	0	0	0	0	0	0	0	0	0	0	0	0	0	0	0	0	0	0	0	1
	↑																								
	↓																								
	bright	0	0	0	0	0	0	0	0	0	0	0	0	0	0	0	0	1	1	1	1	1	1	0	1
	Blue	0	0	0	0	0	0	0	0	0	0	0	0	0	0	0	0	1	1	1	1	1	1	1	1

# PRELIMINARY

4.6.3 262,144 colors

This product can display 262,144 colors with 64 gray scales by combination ②.

(See "4.6.1 Combinations of input data signals and FRC signal".)

Also the relation between display colors and input data signals is as follows.

Display colors		Data signal (0: Low level, 1: High level)																	
		R5	R4	R3	R2	R1	R0	G5	G4	G3	G2	G1	G0	B5	B4	B3	B2	B1	B0
Basic colors	Black	0	0	0	0	0	0	0	0	0	0	0	0	0	0	0	0	0	0
	Blue	0	0	0	0	0	0	0	0	0	0	0	0	1	1	1	1	1	1
	Red	1	1	1	1	1	1	0	0	0	0	0	0	0	0	0	0	0	0
	Magenta	1	1	1	1	1	1	0	0	0	0	0	0	1	1	1	1	1	1
	Green	0	0	0	0	0	0	1	1	1	1	1	1	0	0	0	0	0	0
	Cyan	0	0	0	0	0	0	1	1	1	1	1	1	1	1	1	1	1	1
	Yellow	1	1	1	1	1	1	1	1	1	1	1	1	0	0	0	0	0	0
	White	1	1	1	1	1	1	1	1	1	1	1	1	1	1	1	1	1	1
Red gray scale	Black	0	0	0	0	0	0	0	0	0	0	0	0	0	0	0	0	0	0
	dark	0	0	0	0	0	1	0	0	0	0	0	0	0	0	0	0	0	0
	↑				:						:						:		
	↓				:						:						:		
	bright	1	1	1	1	0	1	0	0	0	0	0	0	0	0	0	0	0	0
Red	1	1	1	1	1	0	0	0	0	0	0	0	0	0	0	0	0	0	
Green gray scale	Black	0	0	0	0	0	0	0	0	0	0	0	0	0	0	0	0	0	0
	dark	0	0	0	0	0	0	0	0	0	0	0	1	0	0	0	0	0	0
	↑				:						:						:		
	↓				:						:						:		
	bright	0	0	0	0	0	0	1	1	1	1	0	1	0	0	0	0	0	0
Green	0	0	0	0	0	0	1	1	1	1	1	1	0	0	0	0	0	0	
Blue gray scale	Black	0	0	0	0	0	0	0	0	0	0	0	0	0	0	0	0	0	0
	dark	0	0	0	0	0	0	0	0	0	0	0	0	0	0	0	0	0	1
	↑				:						:						:		
	↓				:						:						:		
	bright	0	0	0	0	0	0	0	0	0	0	0	0	1	1	1	1	0	1
Blue	0	0	0	0	0	0	0	0	0	0	0	0	1	1	1	1	1	0	

# PRELIMINARY

## 4.7 DISPLAY POSITIONS

The following table is the coordinates per pixel (See "4.8 SCANNING DIRECTIONS".).

C (0, 0)						
R	G	B				
C( 0, 0)	C( 1, 0)	• • •	C( X, 0)	• • •	C(798, 0)	C(799, 0)
C( 0, 1)	C( 1, 1)	• • •	C( X, 1)	• • •	C(798, 1)	C(799, 1)
•	•	•	•	•	•	•
•	•	• • •	•	• • •	•	• • •
•	•	•	•	•	•	•
C( 0, Y)	C( 1, Y)	• • •	C( X, Y)	• • •	C(798, Y)	C(799, Y)
•	•	•	•	•	•	•
•	•	• • •	•	• • •	•	•
•	•	•	•	•	•	•
C( 0, 478)	C( 1, 478)	• • •	C( X, 478)	• • •	C(798, 478)	C(799, 478)
C( 0, 479)	C( 1, 479)	• • •	C( X, 479)	• • •	C(798, 479)	C(799, 479)

## 4.8 SCANNING DIRECTIONS

The following figures are seen from a front view.

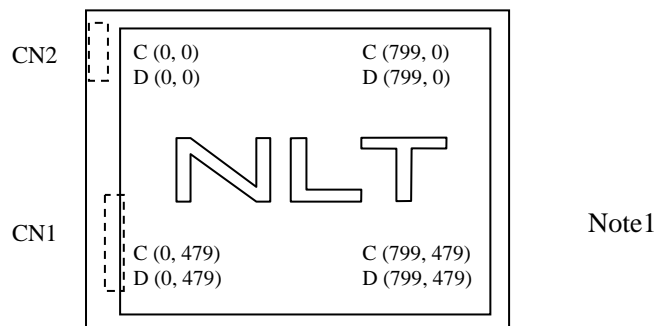

Figure1. Normal scan (DPS: Low or Open)

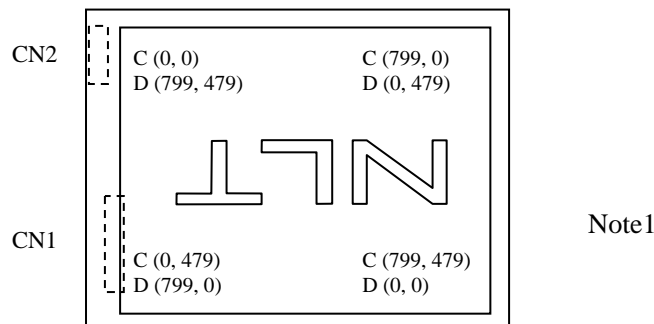

Figure2. Reverse scan (DPS: High)

Note1: Meaning of C (X, Y) and D (X, Y)

C (X, Y): The coordinates of the display position (See "4.7 DISPLAY POSITIONS".)

D (X, Y): The data number of input signal for LCD panel signal processing board

### 4.9 INPUT SIGNAL TIMINGS

#### 4.9.1 Outline of input signal timings

- Horizontal signal

Note1

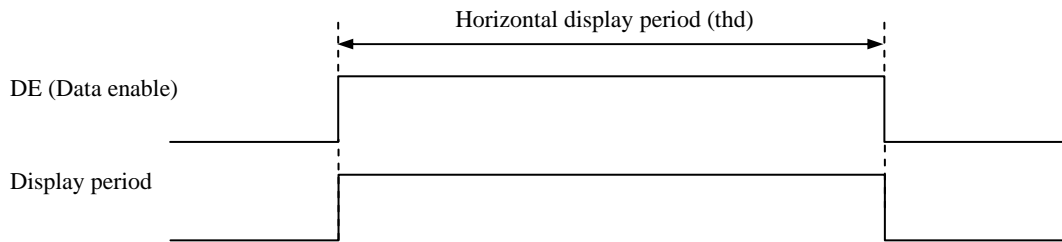

- Vertical signal

Note1

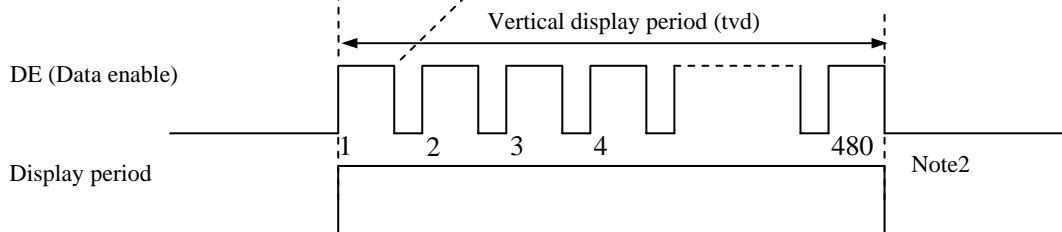

Note1: This diagram indicates virtual signal for set up to timing.

Note2: See "4.9.3 Input signal timing chart" for the pulse number.

# PRELIMINARY

4.9.2 Timing characteristics

(Note1, Note2, Note3)

Parameter		Symbol	min.	typ.	max.	Unit	Remarks	
CLK	Frequency	1/tc	28.0	32.256	36.0	MHz	31.002 ns (typ.)	
	Duty	-	-			-	-	
	Rise time, Fall time	-				ns		
DATA	CLK-DATA	Setup time	-			ns	-	
		Hold time				ns		
	Rise time, Fall time	-				ns		
DE	Horizontal	Cycle	th	28.44	31.746	36.57	μs	31.5 kHz (typ.)
		Display period	thd	800			CLK	
	Vertical (One frame)	Cycle	tv	14.931	16.667	19.19	ms	
		Display period	tvd	480			H	
	CLK-DE	Setup time	-	-			ns	-
		Hold time	-				ns	
Rise time, Fall time		-	ns					

Note1: Definition of parameters is as follows.

$$tc = 1CLK, th = 1H$$

Note2: See the data sheet of LVDS transmitter.

Note3: Vertical cycle (tv) should be specified in integral multiple of Horizontal cycle (th).

4.9.3 Input signal timing chart

Horizontal timing

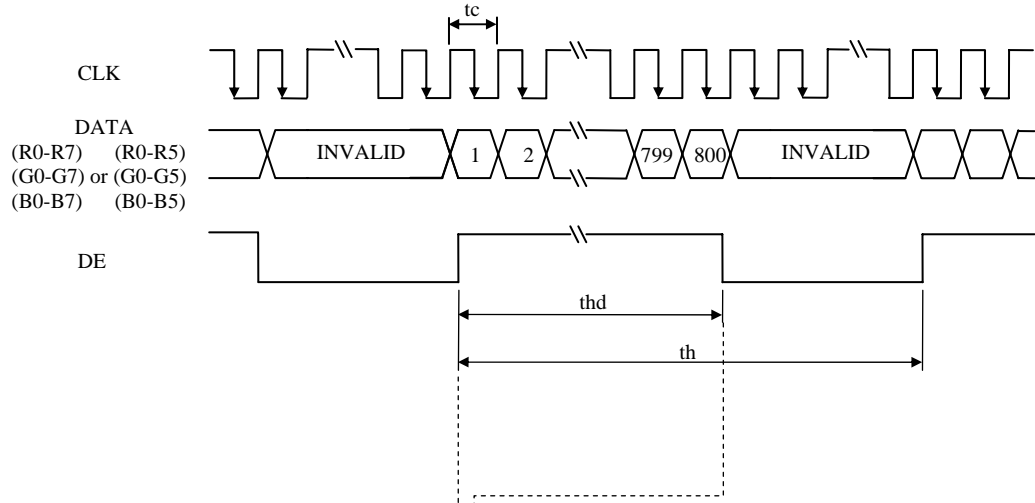

Vertical timing

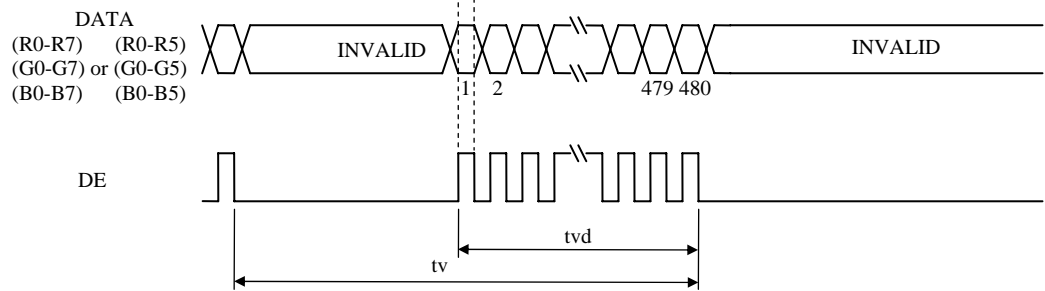

### 4.10 OPTICS

#### 4.10.1 Optical characteristics

(Note1, Note2)

Parameter	Condition	Symbol	min.	typ.	max.	Unit	Measuring instrument	Remarks	
Luminance	White at center $\theta_R=0^\circ, \theta_L=0^\circ, \theta_U=0^\circ, \theta_D=0^\circ$	L	(300)	(500)	-	cd/m <sup>2</sup>	BM-5A	-	
Contrast ratio	White/Black at center $\theta_R=0^\circ, \theta_L=0^\circ, \theta_U=0^\circ, \theta_D=0^\circ$	CR	(300)	(600)	-	-	BM-5A	Note3	
Luminance uniformity	White $\theta_R=0^\circ, \theta_L=0^\circ, \theta_U=0^\circ, \theta_D=0^\circ$	LU	-	1.25	1.4	-	BM-5A	Note4	
Chromaticity	White	x coordinate	Wx	0.263	0.313	0.363	-	SR-3	Note5
		y coordinate	Wy	0.279	0.329	0.379	-		
	Red	x coordinate	Rx	-	0.634	-	-		
		y coordinate	Ry	-	0.348	-	-		
	Green	x coordinate	Gx	-	0.321	-	-		
		y coordinate	Gy	-	0.565	-	-		
Blue	x coordinate	Bx	-	0.138	-	-			
	y coordinate	By	-	0.074	-	-			
Color gamut	$\theta_R=0^\circ, \theta_L=0^\circ, \theta_U=0^\circ, \theta_D=0^\circ$ at center, against NTSC color space	C	55	60	-	%			
Response time	Black to White	Ton	-	(6)	(15)	ms	BM-5A	Note6	
	White to Black	Toff	-	(19)	(47)	ms		Note7	
Viewing angle	Right	$\theta_U=0^\circ, \theta_D=0^\circ, CR \geq 10$	$\theta_R$	70	80	-	EZ Contrast	Note8	
	Left	$\theta_U=0^\circ, \theta_D=0^\circ, CR \geq 10$	$\theta_L$	70	80	-			
	Up	$\theta_R=0^\circ, \theta_L=0^\circ, CR \geq 10$	$\theta_U$	70	80	-			
	Down	$\theta_R=0^\circ, \theta_L=0^\circ, CR \geq 10$	$\theta_D$	(70)	(80)	-			

Note1: These are initial characteristics.

Note2: Measurement conditions are as follows.

Ta= 25°C, VCC= 3.3V, IL= (50)mA/One circuit, Display mode: WVGA,

Horizontal cycle= 1/31.5kHz, Vertical cycle= 1/60.0Hz, DPS= Low or Open: Normal scan

Optical characteristics are measured at luminance saturation 20minutes after the product works in the dark room. Also measurement methods are as follows.

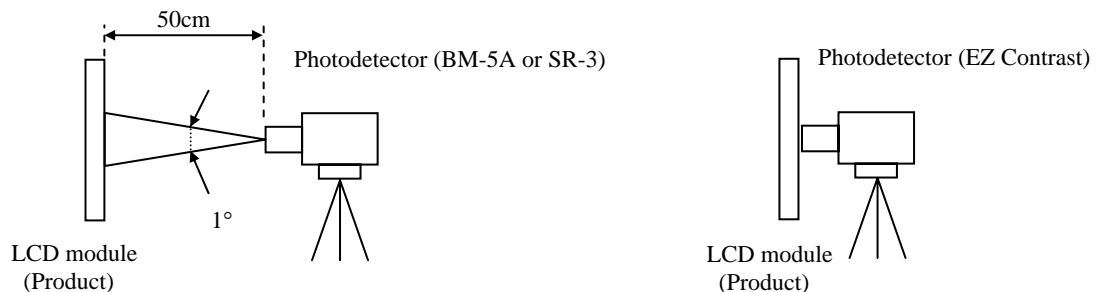

Note3: See "4.10.2 Definition of contrast ratio".

Note4: See "4.10.3 Definition of luminance uniformity".

Note5: These coordinates are found on CIE 1931 chromaticity diagram.

Note6: Product surface temperature: TopF= (28) °C

Note7: See "4.10.4 Definition of response times".

Note8: See "4.10.5 Definition of viewing angles".

4.10.2 Definition of contrast ratio

The contrast ratio is calculated by using the following formula.

$$\text{Contrast ratio (CR)} = \frac{\text{Luminance of white screen}}{\text{Luminance of black screen}}$$

4.10.3 Definition of luminance uniformity

The luminance uniformity is calculated by using following formula.

$$\text{Luminance uniformity (LU)} = \frac{\text{Maximum luminance from ① to ⑤}}{\text{Minimum luminance from ① to ⑤}}$$

The luminance is measured at near the 5 points shown below.

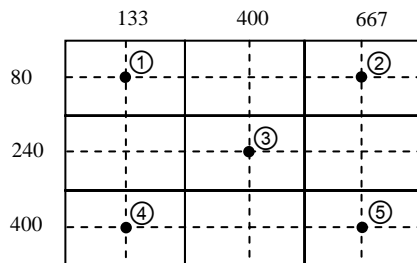

4.10.4 Definition of response times

Response time is measured at the time when the luminance changes from "white" to "black", or "black" to "white" on the same screen point, by photo-detector. Ton is the time when the luminance changes from 90% down to 10%. Also Toff is the time when the luminance changes from 10% up to 90% (See the following diagram.).

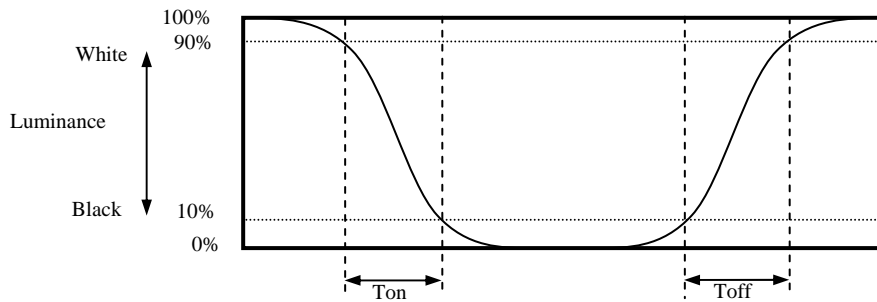

4.10.5 Definition of viewing angles

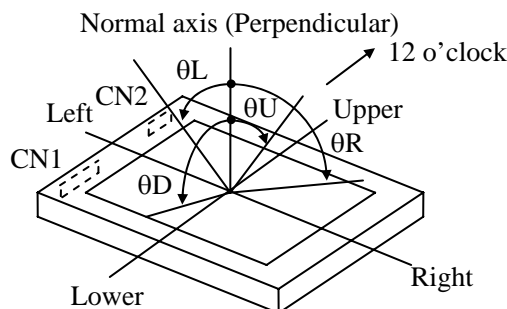



# PRELIMINARY

## 5. ESTIMATED LUMINANCE LIFETIME

The luminance lifetime is the time from initial luminance to half-luminance.

**This lifetime is the estimated value, and is not guarantee value.**

Condition		Estimated luminance lifetime (Life time expectancy) Note1, Note2, Note3	Unit
LED elementary substance	25°C (Ambient temperature of the product) Continuous operation, IL= (50)mA/One circuit	70,000	h
	70°C (Surface temperature at screen) Continuous operation, IL= (50)mA/One circuit	60,000	h

Note1: Life time expectancy is mean time to half-luminance.

Note2: Estimated luminance lifetime is not the value for an LCD module but the value for LED elementary substance.

Note3: By ambient temperature, the lifetime changes particularly. Especially, in case the product works under high temperature environment, the lifetime becomes short.

# PRELIMINARY

## 6. RELIABILITY TESTS

Test item	Condition	Judgment	Note1
High temperature and humidity (Operation)	① $60 \pm 2^{\circ}\text{C}$ , RH= 90%, 240hours ② Display data is Black.	No display malfunctions	
High temperature (Operation)	① $70 \pm 3^{\circ}\text{C}$ , 240hours ② Display data is Black.		
Heat cycle (Operation)	① $-20 \pm 3^{\circ}\text{C}$ ...1hour $70 \pm 3^{\circ}\text{C}$ ...1hour ② 50cycles, 4 hours/cycle ③ Display data is Black.		
Thermal shock (Non operation)	① $-30 \pm 3^{\circ}\text{C}$ ...30minutes $80 \pm 3^{\circ}\text{C}$ ...30minutes ② 100cycles, 1hour/cycle ③ Temperature transition time is within 5 minutes.		
ESD (Operation)	① 150pF, 150Ω, $\pm 10\text{kV}$ ② 9 places on a panel surface Note2 ③ 10 times each places at 1 sec interval		
Dust (Operation)	① Sample dust: No. 15 (by JIS-Z8901) ② 15 seconds stir ③ 8 times repeat at 1 hour interval		
Vibration (Non operation)	① 5 to 100Hz, $19.6\text{m/s}^2$ ② 1 minute/cycle ③ X, Y, Z directions ④ 120 times each directions		
Mechanical shock (Non operation)	① $539\text{m/s}^2$ , 11ms ② $\pm X$ , $\pm Y$ , $\pm Z$ directions ③ 5 times each directions		

Note1: Display and appearance are checked under environmental conditions equivalent to the inspection conditions of defect criteria.

Note2: See the following figure for discharge points.

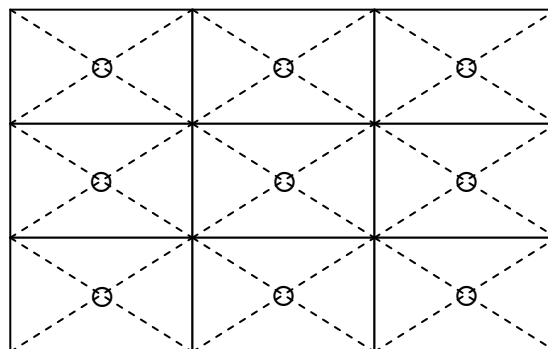

## 7. PRECAUTIONS

### 7.1 MEANING OF CAUTION SIGNS

The following caution signs have very important meaning. **Be sure to read "7.2 CAUTIONS" and "7.3 ATTENTIONS"!**



This sign has the meaning that a customer will be injured or the product will sustain damage if the customer practices wrong operations.



This sign has the meaning that a customer will be injured if the customer practices wrong operations.

### 7.2 CAUTIONS



**\* Do not shock and press the LCD panel and the backlight! There is a danger of breaking, because they are made of glass. (Shock: Equal to or no greater than  $539\text{m/s}^2$  and equal to or no greater than 11ms, Pressure: Equal to or no greater than 19.6 N ( $\phi 16\text{mm}$  jig))**

### 7.3 ATTENTIONS



#### 7.3.1 Handling of the product

- ① Take hold of both ends without touching the circuit board when the product (LCD module) is picked up from inner packing box to avoid broken down or misadjustment, because of stress to mounting parts on the circuit board.
- ② When the product is put on the table temporarily, display surface must be placed downward.
- ③ When handling the product, take the measures of electrostatic discharge with such as earth band, ionic shower and so on, because the product may be damaged by electrostatic.
- ④ The torque for product mounting screws must never exceed 0.147N·m. Higher torque might result in distortion of the bezel.
- ⑤ The product must be installed using mounting holes without undue stress such as bends or twist (See outline drawings). And do not add undue stress to any portion (such as bezel flat area). Bends or twist described above and undue stress to any portion may cause display mura.
- ⑥ Do not press or rub on the sensitive product surface. When cleaning the product surface, wipe it with a soft dry cloth.
- ⑦ Do not push or pull the interface connectors while the product is working.
- ⑧ When handling the product, use of an original protection sheet on the product surface (polarizer) is recommended for protection of product surface. Adhesive type protection sheet may change color or characteristics of the polarizer.
- ⑨ Usually liquid crystals don't leak through the breakage of glasses because of the surface tension of thin layer and the construction of LCD panel. But, if you contact with liquid crystal by any chance, please wash it away with soap and water.

### 7.3.2 Environment

- ① Do not operate or store in high temperature, high humidity, dewdrop atmosphere or corrosive gases. Keep the product in packing box with antistatic pouch in room temperature to avoid dusts and sunlight, when storing the product.
- ② In order to prevent dew condensation occurred by temperature difference, the product packing box must be opened after enough time being left under the environment of an unpacking room. Evaluate the storage time sufficiently because dew condensation is affected by the environmental temperature and humidity. (Recommended leaving time: 6 hours or more with the original packing state after a customer receives the package)
- ③ Do not operate in high magnetic field. If not, circuit boards may be broken.
- ④ This product is not designed as radiation hardened.

### 7.3.3 Characteristics

**The following items are neither defects nor failures.**

- ① Characteristics of the LCD (such as response time, luminance, color uniformity and so on) may be changed depending on ambient temperature. If the product is stored under condition of low temperature for a long time, it may cause display mura. In this case, the product should be operated after enough time being left under condition of operating temperature.
- ② Display mura, flickering, vertical streams or tiny spots may be observed depending on display patterns.
- ③ Do not display the fixed pattern for a long time because it may cause image sticking. Use a screen saver, if the fixed pattern is displayed on the screen.
- ④ The display color may be changed depending on viewing angle because of the use of condenser sheet in the backlight.
- ⑤ Optical characteristics may be changed depending on input signal timings.

### 7.3.4 Others

- ① All VCC and GND terminals should be used without any non-connected lines.
- ② Do not disassemble a product or adjust variable resistors.
- ③ See "REPLACEMENT MANUAL FOR LAMP HOLDER SET", when replacing lamp holder set.
- ④ Pack the product with the original shipping package, in order to avoid any damages during transportation, when returning the product to NLT for repairing and so on.

8. OUTLINE DRAWINGS

8.1 FRONT VIEW

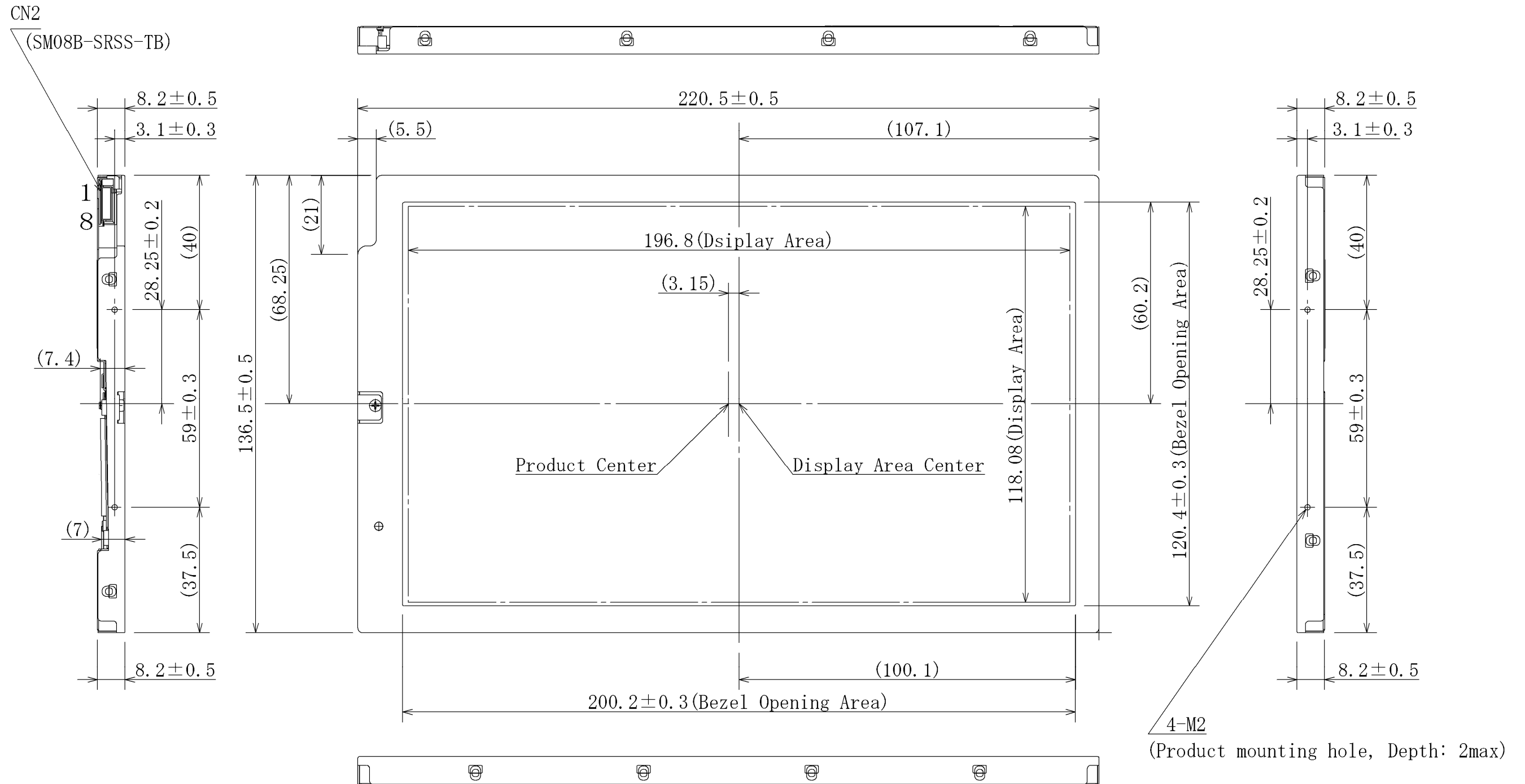

Note1: The values in parentheses are for reference.

Note2: The torque for product mounting screws must never exceed 0.147N·m.

Unit: mm

8.2 REAR VIEW

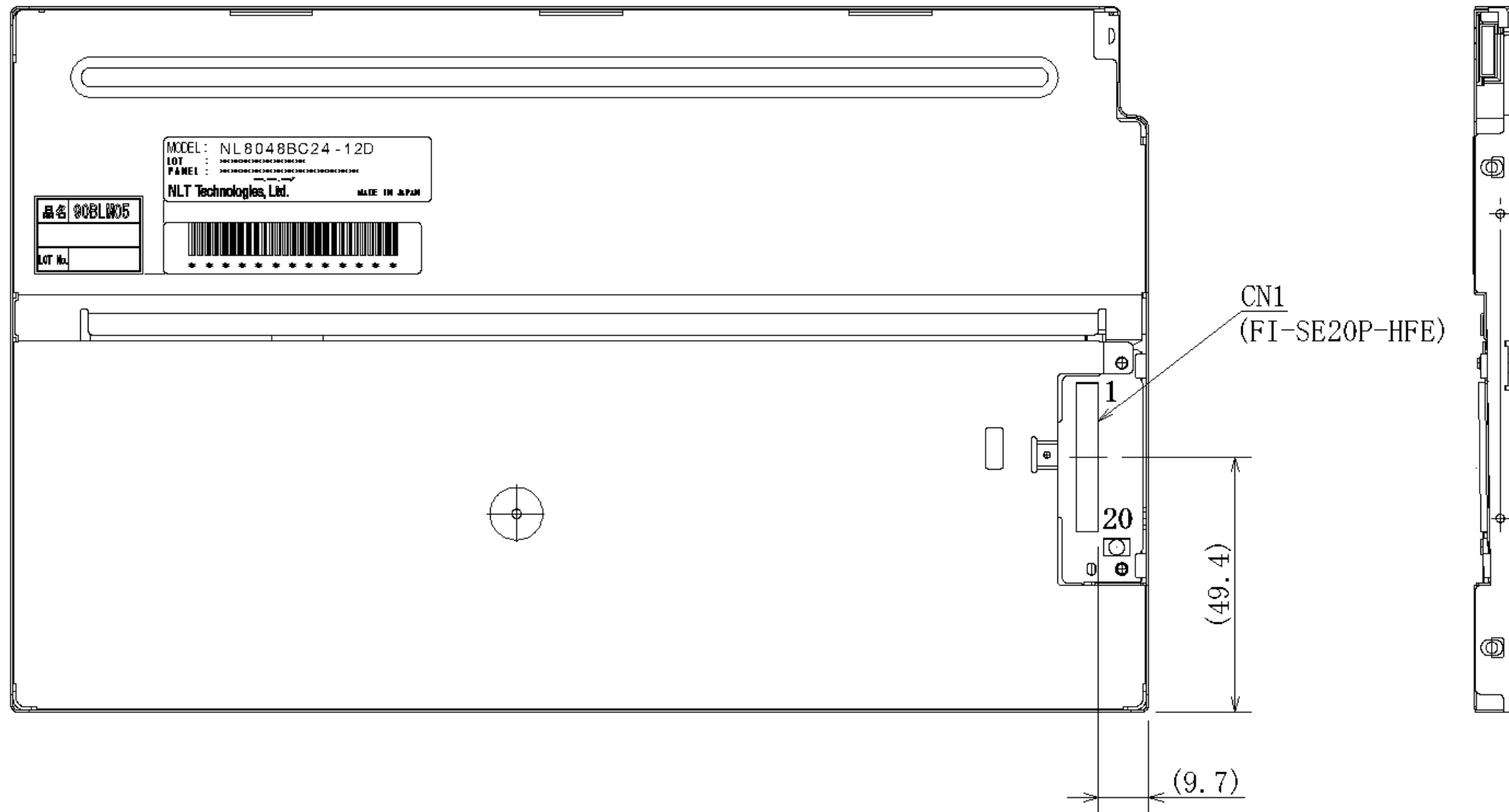







Note1: The values in parentheses are for reference.  
Note2: The torque for product mounting screws must never exceed 0.147N·m.

Unit: mm

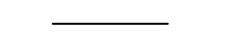
# PRELIMINARY

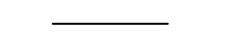
## REVISION HISTORY

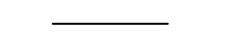
*The inside of latest specifications is revised to the clerical error and the major improvement of previous edition. Only a changed part such as functions, characteristic value and so on that may affect a design of customers, are described especially below.*

Edition	Document number	Prepared date	Revision contents and signature									
1st edition	DOD-PP-1309	Dec. 15, 2011	<p><b>Revision contents</b></p> <p>New issue</p> <p><b>Signature of writer</b></p> <table data-bbox="539 701 1401 824"><tr><td data-bbox="539 701 858 734"><i>Approved by</i></td><td data-bbox="865 701 1104 734"><i>Checked by</i></td><td data-bbox="1110 701 1401 734"><i>Prepared by</i></td></tr><tr><td data-bbox="539 734 858 779"></td><td data-bbox="865 734 1104 779"></td><td data-bbox="1110 734 1401 779"></td></tr><tr><td data-bbox="539 779 858 824">T. OGAWA</td><td data-bbox="865 779 1104 824"></td><td data-bbox="1110 779 1401 824">A. KUMANO</td></tr></table>	<i>Approved by</i>	<i>Checked by</i>	<i>Prepared by</i>				T. OGAWA		A. KUMANO
<i>Approved by</i>	<i>Checked by</i>	<i>Prepared by</i>										
												
T. OGAWA		A. KUMANO										