

PRELIMINARY

NLT Technologies, Ltd.

TFT COLOR LCD MODULE

NL8048AC19-14F

18cm (7.0 Type)

WVGA

LVDS interface (1port)

PRELIMINARY DATA SHEET 

DOD-PP-1762 (2nd edition)

This PRELIMINARY DATA SHEET is updated document from DOD-PP-1688(1).

All information is subject to change without notice. Please confirm the sales representative before starting to design your system.

PRELIMINARY

NLT Technologies, Ltd.

NL8048AC19-14F

INTRODUCTION

The Copyright to this document belongs to NLT Technologies, Ltd. (hereinafter called "NLT"). No part of this document will be used, reproduced or copied without prior written consent of NLT.

NLT does and will not assume any liability for infringement of patents, copyrights or other intellectual property rights of any third party arising out of or in connection with application of the products described herein except for that directly attributable to mechanisms and workmanship thereof. No license, express or implied, is granted under any patent, copyright or other intellectual property right of NLT.

Some electronic products would fail or malfunction at a certain rate. In spite of every effort to enhance reliability of products by NLT, the possibility of failures and malfunction might not be avoided entirely. To prevent the risks of damage to death, human bodily injury or other property arising out thereof or in connection therewith, each customer is required to take sufficient measures in its safety designs and plans including, but not limited to, redundant system, fire-containment and anti-failure.

The products are classified into three grades: "**Standard**", "**Special**", and "**Specific**".

Each quality grade is designed for applications described below. Any customer who intends to use a product for application other than that of Standard is required to contact an NLT sales representative in advance.

The Standard: Applications as any failure, malfunction or error of the products are free from any damage to death, human bodily injury or other property (Products Safety Issue) and not related the safety of the public (Social Issues), like general electric devices.

Examples: Office equipment, audio and visual equipment, communication equipment, test and measurement equipment, personal electronic equipment, home electronic appliances, car navigation system (with no vehicle control functions), seat entertainment monitor for vehicles and airplanes, fish finder (except marine radar integrated type), PDA, etc.

The Special: Applications as any failure, malfunction or error of the products might directly cause any damage to death, human bodily injury or other property (Products Safety Issue) and the safety of the public (Social Issues) and required high level reliability by conventional wisdom.

Examples: Vehicle/train/ship control system, traffic signals system, traffic information control system, air traffic control system, surgery/operation equipment monitor, disaster/crime prevention system, etc.

The Specific: Applications as any failure, malfunction or error of the products might severe cause any damage to death, human bodily injury or other property (Products Safety Issue) and the safety of the public (Social Issues) and developed, designed and manufactured in accordance with the standards or quality assurance program designated by the customer who requires extremely high level reliability and quality.

Examples: Aerospace system (except seat entertainment monitor), nuclear control system, life support system, etc.

The quality grade of this product is the "**Standard**" unless otherwise specified in this document.

PRELIMINARY

CONTENTS

INTRODUCTION	2
1. OUTLINE.....	4
1.1 STRUCTURE AND PRINCIPLE	4
1.2 APPLICATION	4
1.3 FEATURES	4
2. GENERAL SPECIFICATIONS.....	5
3. BLOCK DIAGRAM.....	6
4. DETAILED SPECIFICATIONS.....	7
4.1 MECHANICAL SPECIFICATIONS	7
4.2 ABSOLUTE MAXIMUM RATINGS.....	7
4.3 ELECTRICAL CHARACTERISTICS.....	8
4.3.1 LCD panel signal processing board	8
4.3.2 LED driver	8
4.3.3 Power supply voltage ripple.....	9
4.3.4 Fuse.....	9
4.4 POWER SUPPLY VOLTAGE SEQUENCE	10
4.4.1 LCD panel signal processing board	10
4.4.2 LED driver	10
4.5 CONNECTIONS AND FUNCTIONS FOR INTERFACE PINS	11
4.5.1 LCD panel signal processing board	11
4.5.2 LED driver	12
4.5.3 Positions of plug and socket	12
4.5.4 Connection between receiver and transmitter for LVDS	13
4.5.5 Input data mapping	14
4.6 DISPLAY COLORS AND INPUT DATA SIGNALS.....	14
4.7 DISPLAY POSITIONS	15
4.8 SCANNING DIRECTIONS	15
4.9 INPUT SIGNAL TIMINGS	16
4.9.1 Outline of input signal timings	16
4.9.2 Timing characteristics.....	17
4.9.3 Input signal timing chart	18
4.10 OPTICS.....	19
4.10.1 Optical characteristics	19
4.10.2 Definition of contrast ratio.....	20
4.10.3 Definition of luminance uniformity	20
4.10.4 Definition of response times	20
4.10.5 Definition of viewing angles.....	20
5. ESTIMATED LUMINANCE LIFETIME.....	21
6. RELIABILITY TESTS	22
7. PRECAUTIONS	23
7.1 MEANING OF CAUTION SIGNS	23
7.2 CAUTIONS	23
7.3 ATTENTIONS.....	23
7.3.1 Handling of the product	23
7.3.2 Environment.....	24
7.3.3 Characteristics.....	24
7.3.4 Others.....	24
8. OUTLINE DRAWINGS.....	25
8.1 FRONT VIEW	25
8.2 REAR VIEW	26
REVISION HISTORY	27

1. OUTLINE

1.1 STRUCTURE AND PRINCIPLE

Color LCD module NL8048AC19-14F is composed of the amorphous silicon thin film transistor liquid crystal display (a-Si TFT LCD) panel structure with driver LSIs for driving the TFT (Thin Film Transistor) array and a backlight.

The a-Si TFT LCD panel structure is injected liquid crystal material into a narrow gap between the TFT array glass substrate and a color-filter glass substrate.

Color (Red, Green, Blue) data signals from a host system (e.g. signal generator, etc.) are modulated into best form for active matrix system by a signal processing circuit, and sent to the driver LSIs which drive the individual TFT arrays.

The TFT array as an electro-optical switch regulates the amount of transmitted light from the backlight assembly, when it is controlled by data signals. Color images are created by regulating the amount of transmitted light through the TFT array of red, green and blue dots.

1.2 APPLICATION

- For industrial use

1.3 FEATURES

- High luminance
- High contrast
- Wide viewing angle
- LVDS interface
- Reversible-scan direction
- LED backlight
- Built in LED driver

PRELIMINARY

NLT Technologies, Ltd.

NL8048AC19-14F

2. GENERAL SPECIFICATIONS

Display area	152.4 (H) × 91.44 (V) mm
Diagonal size of display	18cm (7.0 inches)
Drive system	a-Si TFT active matrix
Display color	262,144 colors
Pixel	800 (H) × 480 (V) pixels
Pixel arrangement	RGB (Red dot, Green dot, Blue dot) vertical stripe
Dot pitch	0.0635 (H) × 0.1905 (V) mm
Pixel pitch	0.1905 (H) × 0.1905 (V) mm
Module size	170.0 (H) × 111.0 (V) × 8.5 (D) mm (typ.)
Weight	TBD g (typ.)
Contrast ratio	(800):1 (typ.)
Viewing angle	At the contrast ratio $\geq 10:1$ <ul style="list-style-type: none"> • Horizontal: Right side 80° (typ.), Left side 80° (typ.) • Vertical: Up side 80° (typ.), Down side 80° (typ.)
Designed viewing direction	At DPS= Low or Open: Normal scan <ul style="list-style-type: none"> • Viewing direction without image reversal: Up side (12 o'clock) • Viewing direction with contrast peak: Down side (6 o'clock) • Viewing angle with optimum grayscale ($\gamma \approx 2.2$): Normal axis (perpendicular)
Polarizer surface	Antiglare
Polarizer pencil-hardness	3H (min.) [by JIS K5600]
Color gamut	At LCD panel center 60 % (typ.) [against NTSC color space]
Response time	Ton+Toff (10%←→90%) (18) ms (typ.)
Luminance	At the maximum luminance control 1000 cd/m ² (typ.)
Signal system	LVDS interface (1port) (Receiver: TBD) 6bit digital signals for data of RGB colors, Dot clock (CLK), Data enable (DE)
Power supply voltage	LCD panel signal processing board: 3.3V LED driver: 12V
Backlight	LED backlight built in LED driver
Power consumption	At the maximum luminance control, Checkered flag pattern TBD W (typ.)

2

2

3. BLOCK DIAGRAM

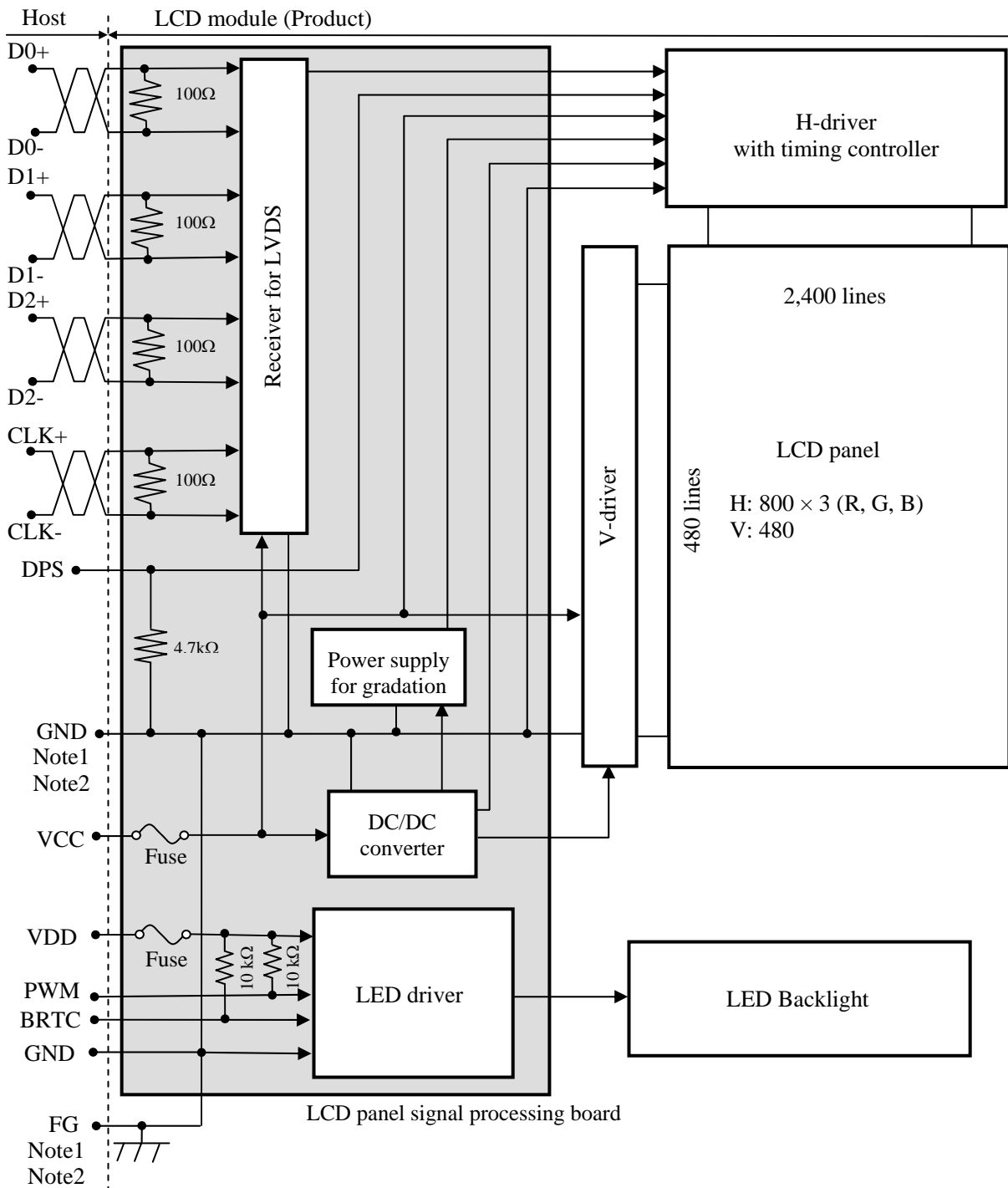

Note1: Relations between GND (Signal ground and LED driver ground) and FG (Frame ground) in the LCD module are as follows.

GND- FG	Connected
---------	-----------

Note2: GND and FG must be connected to customer equipment's ground, and it is recommended that these grounds be connected together in customer equipment.

2

PRELIMINARY

NLT Technologies, Ltd.

NL8048AC19-14F

4. DETAILED SPECIFICATIONS

4.1 MECHANICAL SPECIFICATIONS

Parameter	Specification	Unit
Module size	170.0 ± 0.5 (W) × 111.0 ± 0.5 (H) × 8.5 ± 0.5 (D) Note1	mm
Display area	152.4 (H) × 91.44 (V) Note1	mm
Weight	TBD (typ.), TBD (max.)	g

Note1: See "9. OUTLINE DRAWINGS".

4.2 ABSOLUTE MAXIMUM RATINGS

Parameter	Symbol	Rating	Unit	Remarks		
Power supply voltage	LCD panel signal processing board	VCC	-0.3 to +(4.0)	V	Ta = 25°C	
	LED driver	VDD	-0.3 to +(15)			
Input voltage for signals	Display signals Note1	VD	-0.3 to VCC+0.3	V		
	Function signals Note2	VF				
	Function signal for LED driver	PWM	-0.3 to +(15)	V		
	BRTC	-0.3 to +(15)	V			
Storage temperature		Tst	-30 to +80	°C		-
Operating temperature	Front surface	TopF	-30 to +80	°C		Note3
	Rear surface	TopR	-30 to +80	°C		Note4
Relative humidity Note5	RH	≤ 95	%	Ta ≤ 40°C		
		≤ 85	%	40 < Ta ≤ 50°C		
		≤ 55	%	50 < Ta ≤ 60°C		
		≤ 36	%	60 < Ta ≤ 70°C		
		≤ 24	%	70 < Ta ≤ 80°C		
Absolute humidity Note5		AH	≤ 70	g/m ³	Ta > 70°C	

Note1: D0+/-, D1+/-, D2+/- and CLK+/-

Note2: DPS

Note3: Measured at LCD panel surface (including self-heat)

Note4: Measured at LCD module's rear shield surface (including self-heat)

Note5: No condensation.

PRELIMINARY

4.3 ELECTRICAL CHARACTERISTICS

4.3.1 LCD panel signal processing board

(Ta= 25°C)

Parameter	Symbol	min.	typ.	max.	Unit	Remarks	
Power supply voltage	VCC	3.0	3.3	3.6	V	-	
Power supply current	ICC	-	(160) Note1	(250) Note2	mA	at VCC= 3.3V	
Permissible ripple voltage	VRPC	-	-	100	mVp-p	for VCC	
Differential input threshold voltage	High	VTH	-	-	+100	mV	at VCM= 1.2 V Note3
	Low	VTL	-100	-	-	mV	
Terminating resistance	RT	-	100	-	Ω	-	
Input voltage for DPS signals	High	VFH	0.7VCC	-	VCC	V	CMOS level
	Low	VFL	0	-	0.3VCC	V	
Input current for DPS signal	High	IFH	-	-	(-300)	μA	-
	Low	IFL	(-300)	-	-	μA	

Note1: Checkered flag pattern [by EIAJ ED-2522]

Note2: Pattern for maximum current

Note3: Common mode voltage for LVDS receiver

4.3.2 LED driver

(Ta= 25°C)

Parameter	Symbol	min.	typ.	max.	Unit	Remarks	
Power supply voltage	VDD	10.8	12.0	13.2	V	Note1	
Power supply current Note2	IDD	-	TBD	TBD Note3	mA	Note4	
Permissible ripple voltage	VRPD	-	-	200	mVp-p	for VDD	
Input voltage for PWM signal	High	VDFH1	(2.1)	-	VDD	V	-
	Low	VDFL1	-	-	(0.8)	V	
Input voltage for BRTC signal	High	VDFH2	(2.1)	-	VDD	V	-
	Low	VDFL2	-	-	(0.8)	V	
PWM frequency	f _{PWM}	100	-	(1k)	Hz	Note5, Note6	
PWM duty cycle	DR _{PWM}	(1)	-	100	%	Note7	
PWM pulse width	t _{PWH}	TBD	-	-	μs		

Note1: When designing of the power supply, take the measures for the prevention of surge voltage.

Note2: The power supply lines (VDD and GND) may have ripple voltage during luminance control of LED. There is the possibility that the ripple voltage produces acoustic noise and signal wave noise in audio circuit and so on. Put a capacitor between the power supply lines (VDD and GND) to reduce the noise if necessary.

Note3: This value excludes peak current such as overshoot current.

PRELIMINARY

Note4: At the maximum luminance control.

Note5: A recommended f_{PWM} value is as follows.

$$f_{PWM} = \frac{2n-1}{4} \times fv$$

(n = integer, fv = frame frequency of LCD module)

Note6: Depending on the frequency used, a noise may appear on the screen, please conduct a thorough evaluation.

Note7: While the BRTC signal is high, do not set the tPWH (PWM pulse width) is less than (TBD μ s). It may cause abnormal working of the backlight. In this case, turn the backlight off and then on again by BRTC signal.

4.3.3 Power supply voltage ripple

This product works, even if the ripple voltage levels are over the permissible values as the following table, but there might be noise on the display image.

Power supply voltage		Ripple voltage (Measure at input terminal of power supply)	Note1	Unit
VCC	3.3V	≤ 100		mVp-p
VDD	12.0V	≤ 200		mVp-p

Note1: The permissible ripple voltage includes spike noise.

4.3.4 Fuse

Parameter	Fuse		Rating	Fusing current	Remarks
	Type	Supplier			
VCC	FCC16152AB	KAMAYA ELECTRIC CO.,LTD	1.5A	3.0A	Note1
			36V		
VDD	FCC16152AB	KAMAYA ELECTRIC CO.,LTD	1.5A	3.0A	
			36V		

Note1: The power supply's rated current must be more than the fusing current. If it is less than the fusing current, the fuse may not blow in a short time, and then nasty smell, smoke and so on may occur.

2

4.4 POWER SUPPLY VOLTAGE SEQUENCE

4.4.1 LCD panel signal processing board

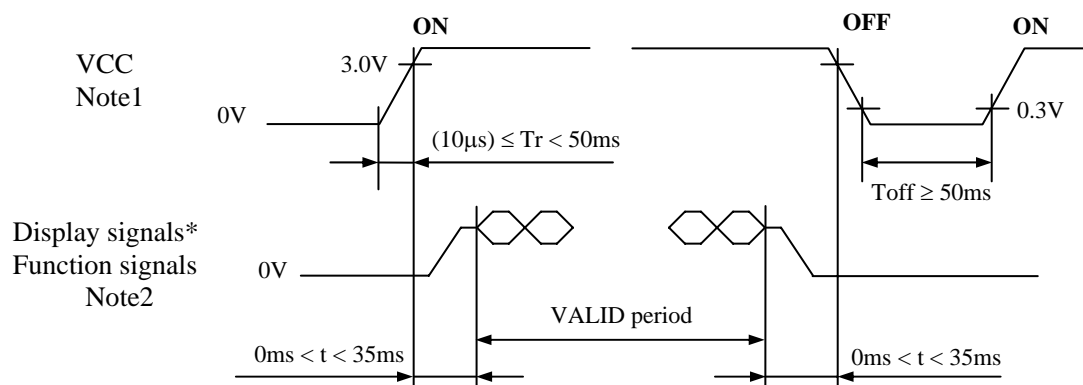

* These signals should be measured at the terminal of 100Ω resistance.

Note1: If there is a voltage variation (voltage drop) at the rising edge of VCC below 3.0V, there is a possibility that a product does not work due to a protection circuit.

Note2: Display signals (D0+/-, D1+/-, D2+/- and CLK+/-) and function signals (DPS) must be set to Low or High-impedance, except the VALID period (See above sequence diagram), in order to avoid the circuitry damage.

If some of display and function signals of this product are cut while this product is working, even if the signal input to it once again, it might not work normally. If a customer stops the display and function signals, VCC also must be shut down.

4.4.2 LED driver

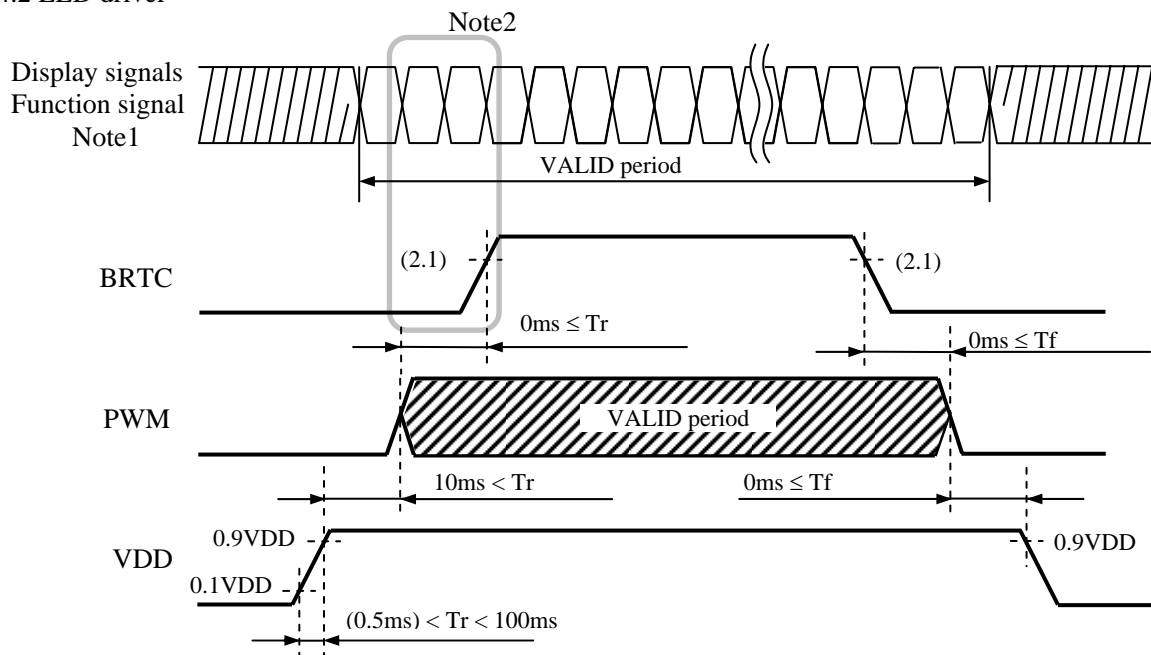

Note1: These are the display and function signals for LCD panel signal processing board.

Note2: The backlight should be turned on within the valid period of display and function signals, in order to avoid unstable data display.

PRELIMINARY

4.5 CONNECTIONS AND FUNCTIONS FOR INTERFACE PINS

4.5.1 LCD panel signal processing board

CN1 socket (LCD module side): FI-SE20P-HFE (Japan Aviation Electronics Industry Limited (JAE))
 Adaptable plug: FI-S20S (Japan Aviation Electronics Industry Limited (JAE))

Pin No.	Symbol	Signal	Remarks
1	GND	Ground	Note4
2	GND		
3	DPS	Selection of scan direction	High : Reverse scan Low or Open : Normal scan Note2
4	N.C.	-	Keep this pin Open.
5	GND	Ground	Note4
6	CLK+	Pixel clock	Note3
7	CLK-		
8	GND	Ground	Note4
9	D2+	Pixel data (B2-B5,DE)	Note1, Note3
10	D2-		
11	GND	Ground	Note4
12	D1+	Pixel data (G1-G5,B0-B1)	Note1, Note3
13	D1-		
14	GND	Ground	Note4
15	D0+	Pixel data (R0-R5,G0)	Note1, Note3
16	D0-		
17	GND	Ground	Note4
18	GND		
19	VCC	Power supply	Note4
20	VCC		

Note1: See "4.6 DISPLAY COLORS AND INPUT DATA SIGNALS".

Note2: See "4.8 SCANNING DIRECTIONS".

Note3: Twist pair wires with 100Ω (Characteristic impedance) should be used between LCD panel signal processing board and LVDS transmitter.

Note4: All GND and VCC terminals should be used without any non-connected lines.

PRELIMINARY

4.5.2 LED driver

CN2 socket (LCD module side): FI-S6P-HFE (Japan Aviation Electronics Industry Limited (JAE))
Adaptable plug: FI-S6S (Japan Aviation Electronics Industry Limited (JAE))

Pin No.	Symbol	Function	Remarks
1	VDD	Power supply	Note1
2	VDD	Power supply	
3	GND	Ground	
4	GND	Ground	
5	BRTC	Backlight ON/OFF control	High or Open: Backlight ON Low: Backlight OFF
6	PWM	Luminance control terminal by PWM Dimming	High or Open: 100% (Max. Luminance)

Note1: All GND and VDD terminals must be connected to appropriate terminals.

4.5.3 Positions of plug and socket

Rear side

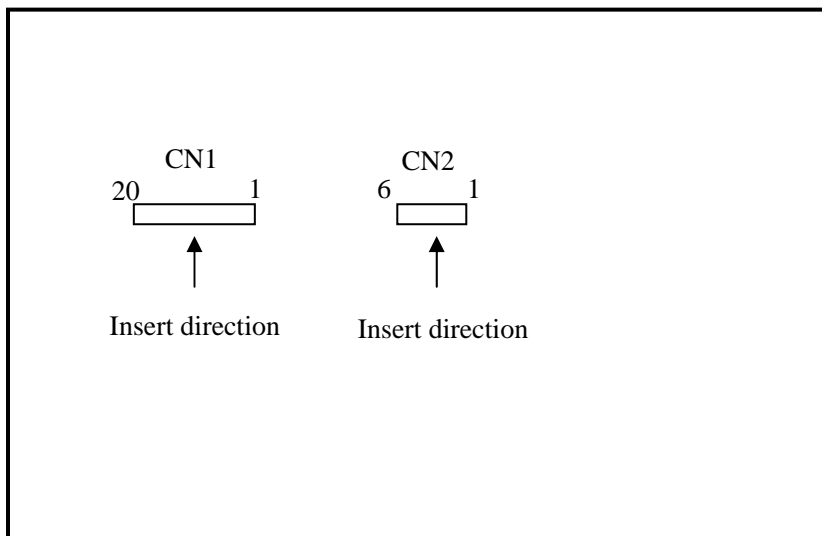

PRELIMINARY

4.5.4 Connection between receiver and transmitter for LVDS

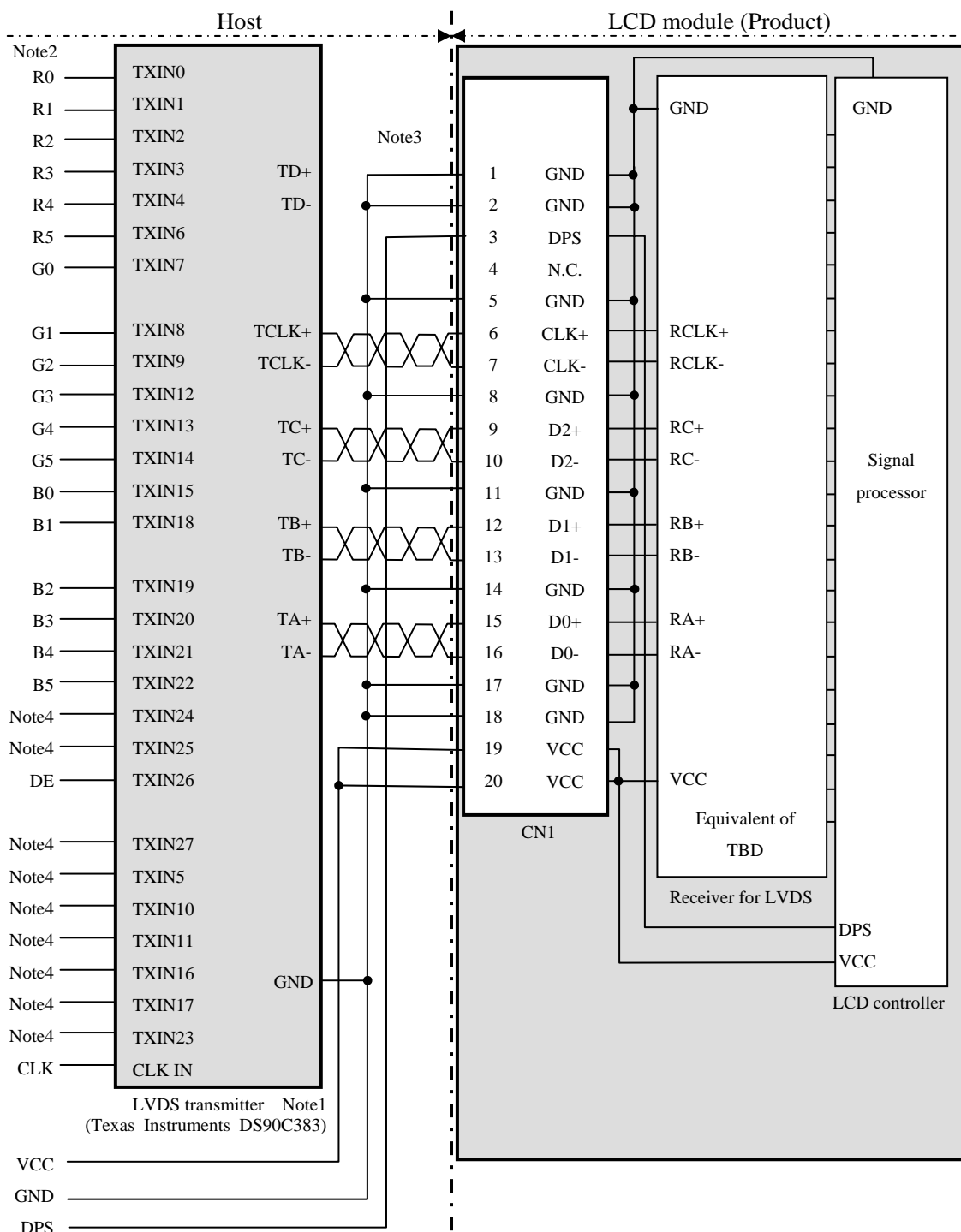

Note1: Recommended transmitter: DS90C383 (Texas Instruments) or equivalent

Note2: LSB (Least Significant Bit) – R0, G0, B0 MSB (Most Significant Bit) – R5, G5, B5

Note3: Twist pair wires with 100Ω (Characteristic impedance) should be used between LCD panel signal processing board and LVDS transmitter.

Note4: Input signals to TXIN24, TXIN25, TXIN27, TXIN5, TXIN10, TXIN11, TXIN16, TXIN17 and TXIN23 are not used inside the product, but do not keep these terminals open to avoid noise problem.

PRELIMINARY

4.5.5 Input data mapping

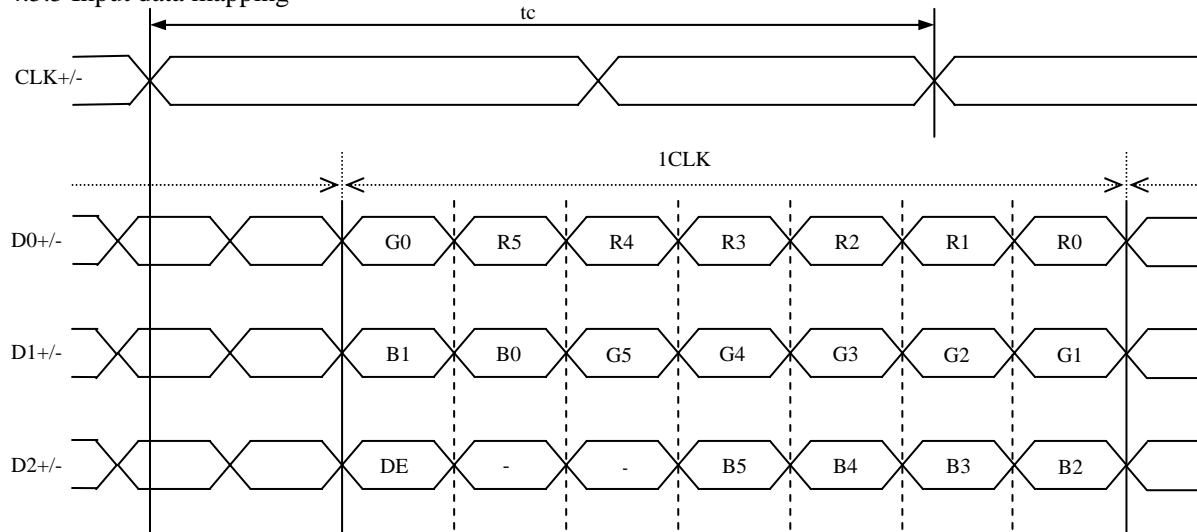

4.6 DISPLAY COLORS AND INPUT DATA SIGNALS

This product can display in equivalent to 262,144 colors in 64 gray scales by combination between input data signals. See following table.

Display colors		Data signal (0: Low level, 1: High level)																	
		R5	R4	R3	R2	R1	R0	G5	G4	G3	G2	G1	G0	B5	B4	B3	B2	B1	B0
Basic colors	Black	0	0	0	0	0	0	0	0	0	0	0	0	0	0	0	0	0	0
	Blue	0	0	0	0	0	0	0	0	0	0	0	0	1	1	1	1	1	1
	Red	1	1	1	1	1	1	0	0	0	0	0	0	0	0	0	0	0	0
	Magenta	1	1	1	1	1	1	0	0	0	0	0	0	1	1	1	1	1	1
	Green	0	0	0	0	0	0	1	1	1	1	1	1	0	0	0	0	0	0
	Cyan	0	0	0	0	0	0	1	1	1	1	1	1	1	1	1	1	1	1
	Yellow	1	1	1	1	1	1	1	1	1	1	1	1	0	0	0	0	0	0
	White	1	1	1	1	1	1	1	1	1	1	1	1	1	1	1	1	1	1
Red gray scale	Black	0	0	0	0	0	0	0	0	0	0	0	0	0	0	0	0	0	0
	dark	0	0	0	0	0	1	0	0	0	0	0	0	0	0	0	0	0	0
	↑				⋮														
	↓				⋮														
	bright	1	1	1	1	0	1	0	0	0	0	0	0	0	0	0	0	0	0
Red	1	1	1	1	1	0	0	0	0	0	0	0	0	0	0	0	0	0	
Green gray scale	Black	0	0	0	0	0	0	0	0	0	0	0	0	0	0	0	0	0	0
	dark	0	0	0	0	0	0	0	0	0	0	1	0	0	0	0	0	0	0
	↑				⋮														
	↓				⋮														
	bright	0	0	0	0	0	0	1	1	1	1	0	1	0	0	0	0	0	0
Green	0	0	0	0	0	0	1	1	1	1	1	1	0	0	0	0	0	0	
Blue gray scale	Black	0	0	0	0	0	0	0	0	0	0	0	0	0	0	0	0	0	0
	dark	0	0	0	0	0	0	0	0	0	0	0	0	0	0	0	0	1	0
	↑				⋮														
	↓				⋮														
	bright	0	0	0	0	0	0	0	0	0	0	0	0	1	1	1	1	0	1
Blue	0	0	0	0	0	0	0	0	0	0	0	0	1	1	1	1	1	0	
Blue	0	0	0	0	0	0	0	0	0	0	0	0	1	1	1	1	1	1	

PRELIMINARY

4.7 DISPLAY POSITIONS

The following table is the coordinates per pixel (See "4.8 SCANNING DIRECTIONS").

C (0, 0)						
R	G	B				
↑						
C(0, 0)	C(1, 0)	...	C(X, 0)	...	C(798, 0)	C(799, 0)
C(0, 1)	C(1, 1)	...	C(X, 1)	...	C(798, 1)	C(799, 1)
.
.
.
C(0, Y)	C(1, Y)	...	C(X, Y)	...	C(798, Y)	C(799, Y)
.
.
.
C(0, 478)	C(1, 478)	...	C(X, 478)	...	C(798, 478)	C(799, 478)
C(0, 479)	C(1, 479)	...	C(X, 479)	...	C(798, 479)	C(799, 479)

4.8 SCANNING DIRECTIONS

The following figures are seen from a front view.

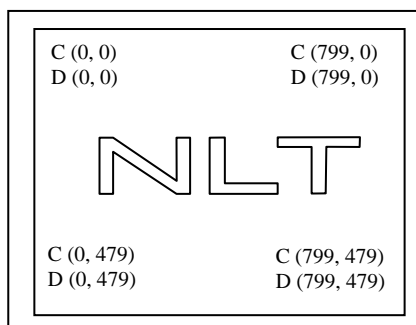

Note1

Figure1. Normal scan (DPS: Low or Open)

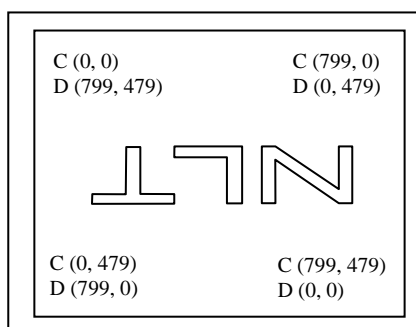

Note1

Figure2. Reverse scan (DPS: High)

Note1: Meaning of C (X, Y) and D (X, Y)

C (X, Y): The coordinates of the display position (See "4.7 DISPLAY POSITIONS").

D (X, Y): The data number of input signal for LCD panel signal processing board

4.9 INPUT SIGNAL TIMINGS

4.9.1 Outline of input signal timings

- Horizontal signal

Note1

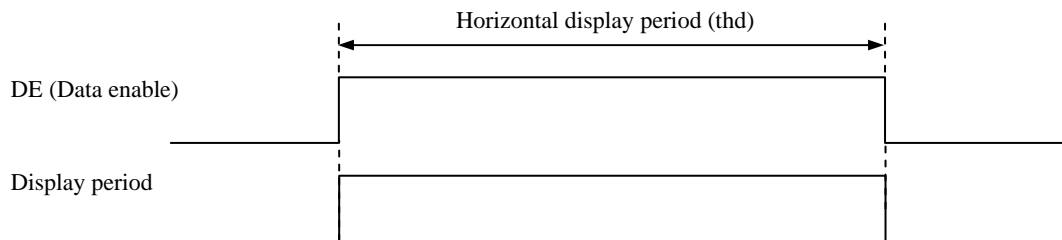

- Vertical signal

Note1

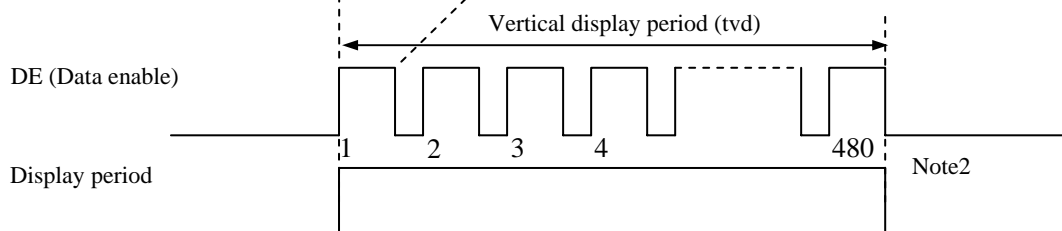

Note1: This diagram indicates virtual signal for set up to timing.

Note2: See "4.9.3 Input signal timing chart" for the pulse number.

PRELIMINARY

4.9.2 Timing characteristics

(Note1, Note2, Note3)

Parameter		Symbol	min.	typ.	max.	Unit	Remarks	
CLK	Frequency	1/tc	28.0	32.256	36.0	MHz	31.002ns (typ.)	
	Duty	-	-			-	-	
	Rise time, Fall time	-				ns		
DATA	CLK-DATA	Setup time	-			ns	-	
		Hold time				ns		
	Rise time, Fall time	-				ns		
DE	Horizontal	Cycle	th	28.44	31.746	36.57	μs	31.5 kHz (typ.)
				-	1,024	-	CLK	
		Display period	thd	800			CLK	-
	Vertical (One frame)	Cycle	tv	14.931	16.667	19.19	ms	60.0 Hz (typ.)
				-	525	-	H	
		Display period	tvd	480			H	
CLK-DE	Setup time	-	-			ns	-	
	Hold time	-				ns		
	Rise time, Fall time	-				ns		

Note1: Definition of parameters is as follows.

$$t_c = 1\text{CLK}, t_h = 1\text{H}$$

Note2: See the data sheet of LVDS transmitter.

Note3: Vertical cycle (tv) should be specified in integral multiple of Horizontal cycle (th).

4.9.3 Input signal timing chart

Horizontal timing

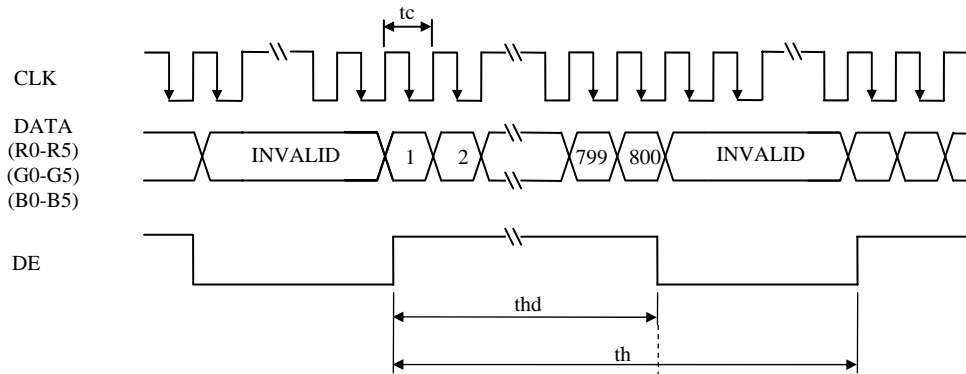

Vertical timing

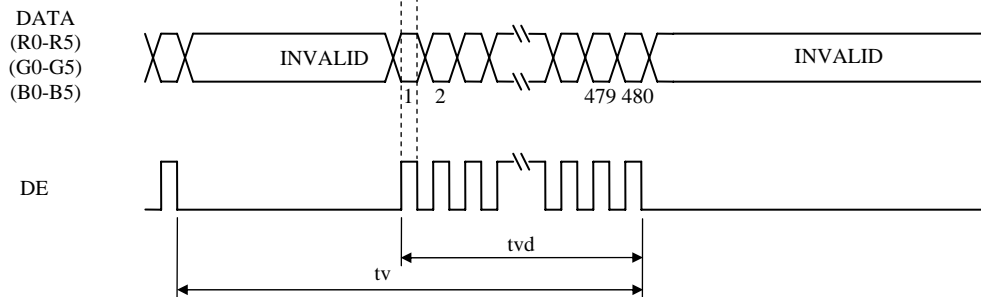

4.10 OPTICS

4.10.1 Optical characteristics

(Note1, Note2)

Parameter	Condition	Symbol	min.	typ.	max.	Unit	Measuring instrument	Remarks	
Luminance	White at center $\theta R=0^\circ, \theta L=0^\circ, \theta U=0^\circ, \theta D=0^\circ$	L	600	1000	-	cd/m ²	BM-5A	-	
Contrast ratio	White/Black at center $\theta R=0^\circ, \theta L=0^\circ, \theta U=0^\circ, \theta D=0^\circ$	CR	(500)	(800)	-	-	BM-5A	Note3	
Luminance uniformity	White $\theta R=0^\circ, \theta L=0^\circ, \theta U=0^\circ, \theta D=0^\circ$	LU	-	(1.25)	(1.4)	-	BM-5A	Note4	
Chromaticity	White	x coordinate	Wx	0.263	0.313	0.363	-	SR-3	Note5
		y coordinate	Wy	0.279	0.329	0.379	-		
	Red	x coordinate	Rx	-	TBD	-	-		
		y coordinate	Ry	-	TBD	-	-		
	Green	x coordinate	Gx	-	TBD	-	-		
		y coordinate	Gy	-	TBD	-	-		
Blue	x coordinate	Bx	-	TBD	-	-			
	y coordinate	By	-	TBD	-	-			
Color gamut	$\theta R=0^\circ, \theta L=0^\circ, \theta U=0^\circ, \theta D=0^\circ$ at center, against NTSC color space	C	55	60	-	%			
Response time	White to Black	Ton	-	TBD	TBD	ms	BM-5A -10000	Note6	
	Black to White	Toff	-	TBD	TBD	ms		Note7	
	Ton + Toff	-	-	(18)	TBD	ms			
Viewing angle	Right	$\theta U=0^\circ, \theta D=0^\circ, CR \geq 10$	θR	(65)	80	-	EZ Contrast	Note8	
	Left	$\theta U=0^\circ, \theta D=0^\circ, CR \geq 10$	θL	(65)	80	-			
	Up	$\theta R=0^\circ, \theta L=0^\circ, CR \geq 10$	θU	(60)	80	-			
	Down	$\theta R=0^\circ, \theta L=0^\circ, CR \geq 10$	θD	(60)	80	-			

Note1: These are initial characteristics.

Note2: Measurement conditions are as follows.

$T_a = 25^\circ\text{C}$, $V_{CC} = 3.3\text{V}$, $V_{DD} = 12.0\text{V}$, PWM: Duty 100%,

Display mode: WVGA, Horizontal cycle = 1/31.5kHz, Vertical cycle = 1/60.0Hz,

DPS= Low or Open: Normal scan

Optical characteristics are measured at luminance saturation 20minutes after the product works, in the dark room. Also measurement methods are as follows.

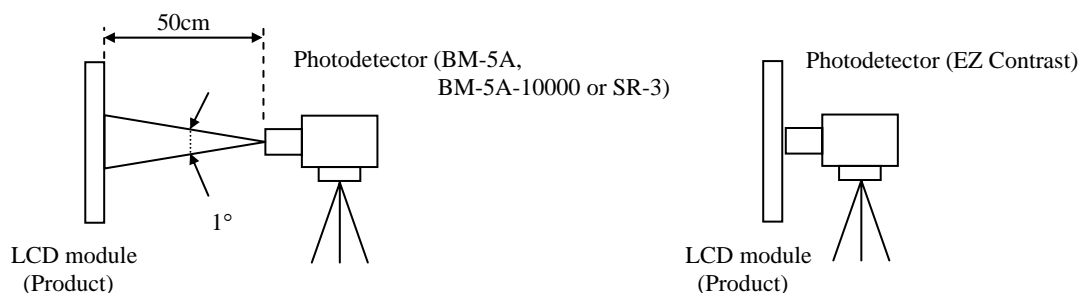

Note3: See "4.10.2 Definition of contrast ratio".

Note4: See "4.10.3 Definition of luminance uniformity".

Note5: These coordinates are found on CIE 1931 chromaticity diagram.

Note6: Product surface temperature: TopF= TBD°C

Note7: See "4.10.4 Definition of response times".

Note8: See "4.10.5 Definition of viewing angles".

PRELIMINARY

4.10.2 Definition of contrast ratio

The contrast ratio is calculated by using the following formula.

$$\text{Contrast ratio (CR)} = \frac{\text{Luminance of white screen}}{\text{Luminance of black screen}}$$

4.10.3 Definition of luminance uniformity

The luminance uniformity is calculated by using following formula.

$$\text{Luminance uniformity (LU)} = \frac{\text{Maximum luminance from ① to ⑤}}{\text{Minimum luminance from ① to ⑤}}$$

The luminance is measured at near the 5 points shown below.

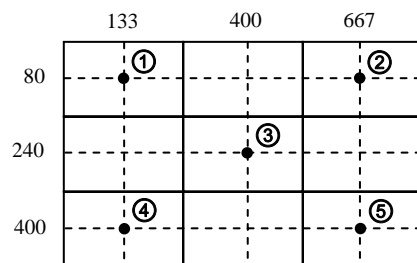

4.10.4 Definition of response times

Response time is measured at the time when the luminance changes from "white" to "black", or "black" to "white" on the same screen point, by photo-detector. Ton is the time when the luminance changes from 90% down to 10%. Also Toff is the time when the luminance changes from 10% up to 90% (See the following diagram.).

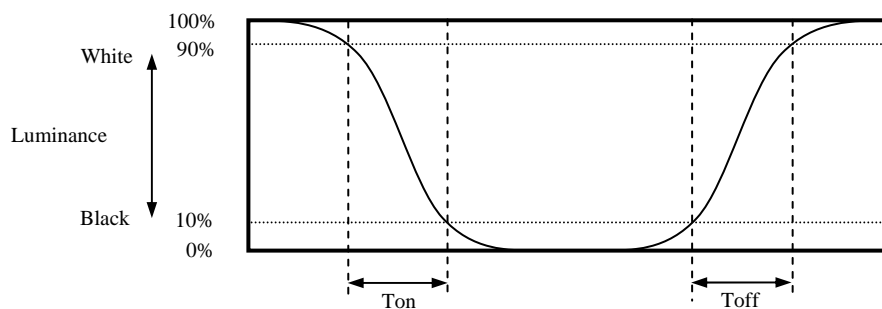

4.10.5 Definition of viewing angles

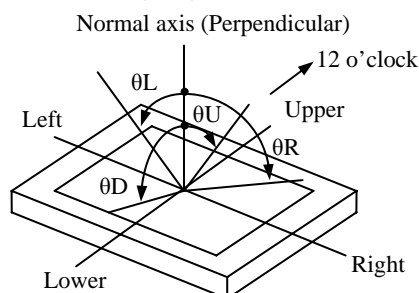

PRELIMINARY

5. ESTIMATED LUMINANCE LIFETIME

The luminance lifetime is the time from initial luminance to half-luminance.

This lifetime is the estimated value, and is not guarantee value.

Condition		Estimated luminance lifetime (Life time expectancy) Note1, Note2, Note3	Unit
LED elementary substance	25°C (Ambient temperature of the product) Continuous operation, PWM Duty:100%	100,000	h

Note1: Life time expectancy is mean time to half-luminance.

Note2: Estimated luminance lifetime is not the value for LCD module but the value for LED elementary substance.

Note3: By ambient temperature, the lifetime changes particularly. Especially, in case the product works under high temperature environment, the lifetime becomes short.

PRELIMINARY

6. RELIABILITY TESTS

Test item	Condition	Judgment	Note1
High temperature and humidity (Operation)	① $60 \pm 2^\circ\text{C}$, RH= 90%, 240hours ② Display data is black.	No display malfunctions	
High temperature (Operation)	① $80 \pm 3^\circ\text{C}$, 240hours ② Display data is black.		
Heat cycle (Operation)	① $-30 \pm 3^\circ\text{C}$...1hour $80 \pm 3^\circ\text{C}$...1hour ② 50cycles, 4 hours/cycle ③ Display data is black.		
Thermal shock (Non operation)	① $-30 \pm 3^\circ\text{C}$...30minutes $80 \pm 3^\circ\text{C}$...30minutes ② 100cycles, 1hour/cycle ③ Temperature transition time is within 5 minutes.		
ESD (Operation)	Contact Discharge ① 150pF, 150Ω, $\pm 10\text{kV}$ ② 9 places on a panel surface Note2 ③ 10 times each places at 1 sec interval		
Dust (Operation)	① Sample dust: No. 15 (by JIS-Z8901) ② 15 seconds stir ③ 8 times repeat at 1 hour interval		
Vibration (Non operation)	① 5 to 100Hz, 19.6m/s^2 ② 1 minute/cycle ③ X, Y, Z directions ④ 120 times each directions		
Mechanical shock (Non operation)	① 539m/s^2 , 11ms ② X, Y, Z directions ③ 5 times each directions		

Note1: Display and appearance are checked under environmental conditions equivalent to the inspection conditions of defect criteria.

Note2: See the following figure for discharge points.

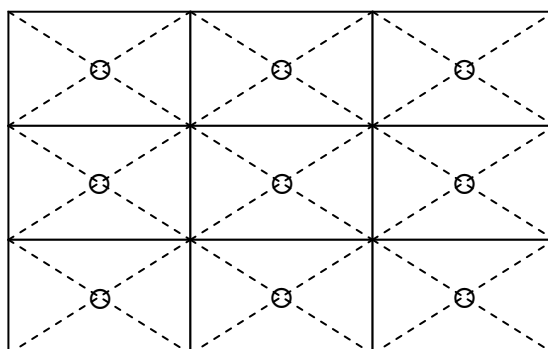

7. PRECAUTIONS

7.1 MEANING OF CAUTION SIGNS

The following caution signs have very important meaning. **Be sure to read "7.2 CAUTIONS" and "7.3 ATTENTIONS"!**



This sign has the meaning that a customer will be injured or the product will sustain damage if the customer practices wrong operations.



This sign has the meaning that a customer will be injured if the customer practices wrong operations.

7.2 CAUTIONS



*** Do not shock and press the LCD panel and the backlight! There is a danger of breaking, because they are made of glass. (Shock: Equal to or no greater than 539m/s^2 and equal to or no greater than 11ms, Pressure: Equal to or no greater than 19.6 N ($\phi 16\text{mm}$ jig))**



7.3 ATTENTIONS

7.3.1 Handling of the product

- ① Take hold of both ends without touching the circuit board when the product (LCD module) is picked up from inner packing box to avoid broken down or misadjustment, because of stress to mounting parts on the circuit board.
- ② When the product is put on the table temporarily, display surface must be placed downward.
- ③ When handling the product, take the measures of electrostatic discharge with such as earth band, ionic shower and so on, because the product may be damaged by electrostatic.
- ④ The torque for product mounting screws must never exceed 0.23 N·m. Higher torque might result in distortion of the bezel. And the length of product mounting screws must be ≤ 2.0 mm.
- ⑤ The product must be installed using mounting holes without undue stress such as bends or twist (See outline drawings). And do not add undue stress to any portion (such as bezel flat area). Bends or twist described above and undue stress to any portion may cause display mura.
- ⑥ Do not press or rub on the sensitive product surface. When cleaning the panel surface, wipe it with a soft dry cloth.
- ⑦ Do not push or pull the interface connectors while the product is working.
- ⑧ When handling the product, use of an original protection sheet on the product surface (polarizer) is recommended for protection of product surface. Adhesive type protection sheet may change color or characteristics of the polarizer.
- ⑨ Usually liquid crystals don't leak through the breakage of glasses because of the surface tension of thin layer and the construction of LCD panel. But, if you contact with liquid crystal by any chance, please wash it away with soap and water.

7.3.2 Environment

- ① Do not operate or store in high temperature, high humidity, dewdrop atmosphere or corrosive gases. Keep the product in packing box with antistatic pouch in room temperature to avoid dusts and sunlight, when storing the product.
- ② In order to prevent dew condensation occurred by temperature difference, the product packing box must be opened after enough time being left under the environment of an unpacking room. Evaluate the storage time sufficiently because dew condensation is affected by the environmental temperature and humidity. (Recommended leaving time: 6 hours or more with the original packing state after a customer receives the package)
- ③ Do not operate in high magnetic field. If not, circuit boards may be broken.
- ④ This product is not designed as radiation hardened.

7.3.3 Characteristics

The following items are neither defects nor failures.

- ① Characteristics of the LCD (such as response time, luminance, color uniformity and so on) may be changed depending on ambient temperature. If the product is stored under condition of low temperature for a long time, it may cause display mura. In this case, the product should be operated after enough time being left under condition of operating temperature.
- ② Display mura, flickering, vertical streams or tiny spots may be observed depending on display patterns.
- ③ Do not display the fixed pattern for a long time because it may cause image sticking. Use a screen saver, if the fixed pattern is displayed on the screen.
- ④ The display color may be changed depending on viewing angle because of the use of condenser sheet in the backlight.
- ⑤ Optical characteristics may be changed depending on input signal timings.

7.3.4 Others

- ① All GND, VCC and VDD terminals should be used without any non-connected lines.
- ② Do not disassemble a product or adjust variable resistors.
- ③ Pack the product with the original shipping package, in order to avoid any damages during transportation, when returning the product to NLT.

8. OUTLINE DRAWINGS

8.1 FRONT VIEW

2

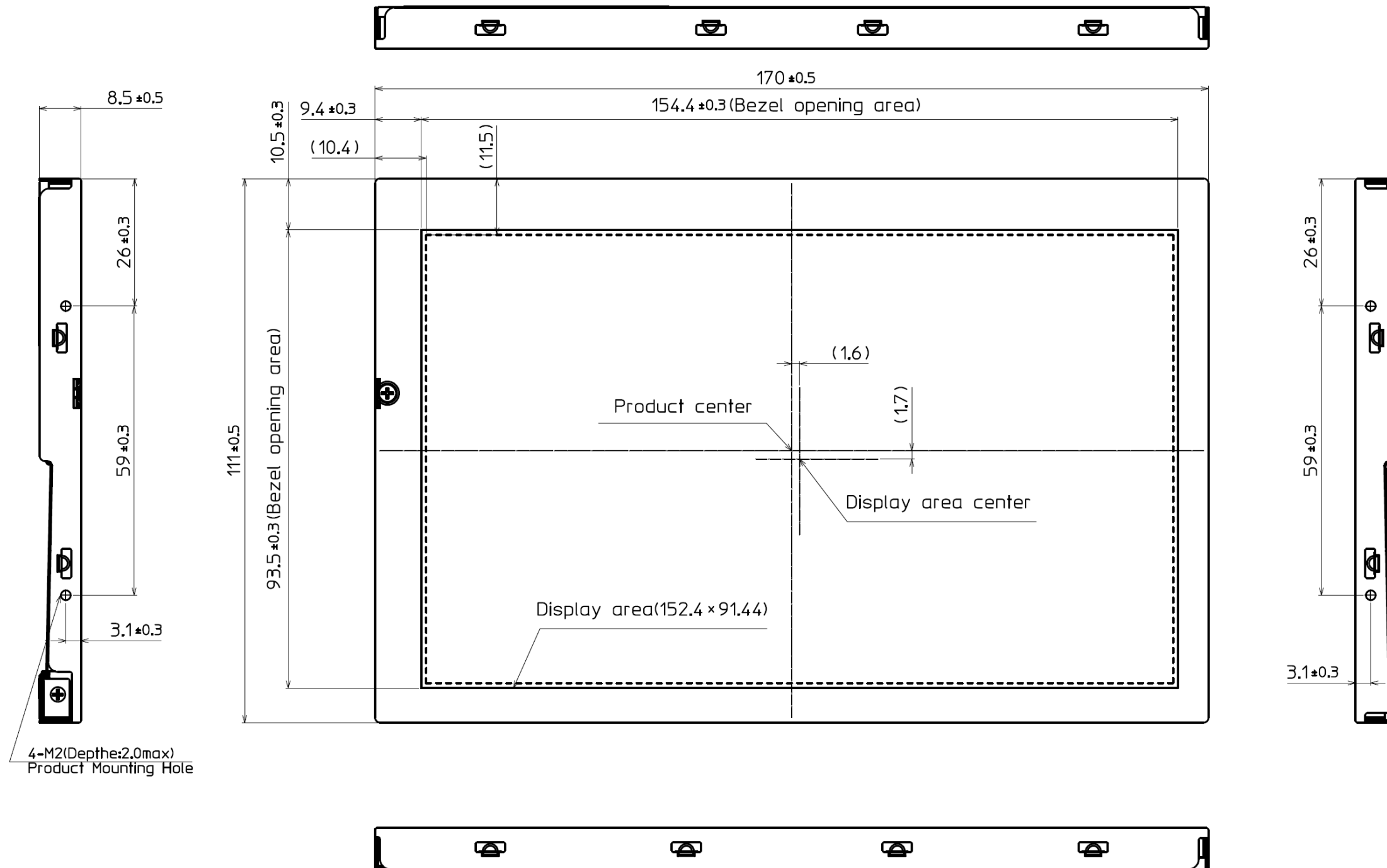

Unit: mm

Note1: The values in parentheses are for reference.

Note2: The torque for product mounting screws must never exceed 0.23 N·m. And the length of product mounting screws must be ≤ 2.0 mm.

8.2 REAR VIEW

2

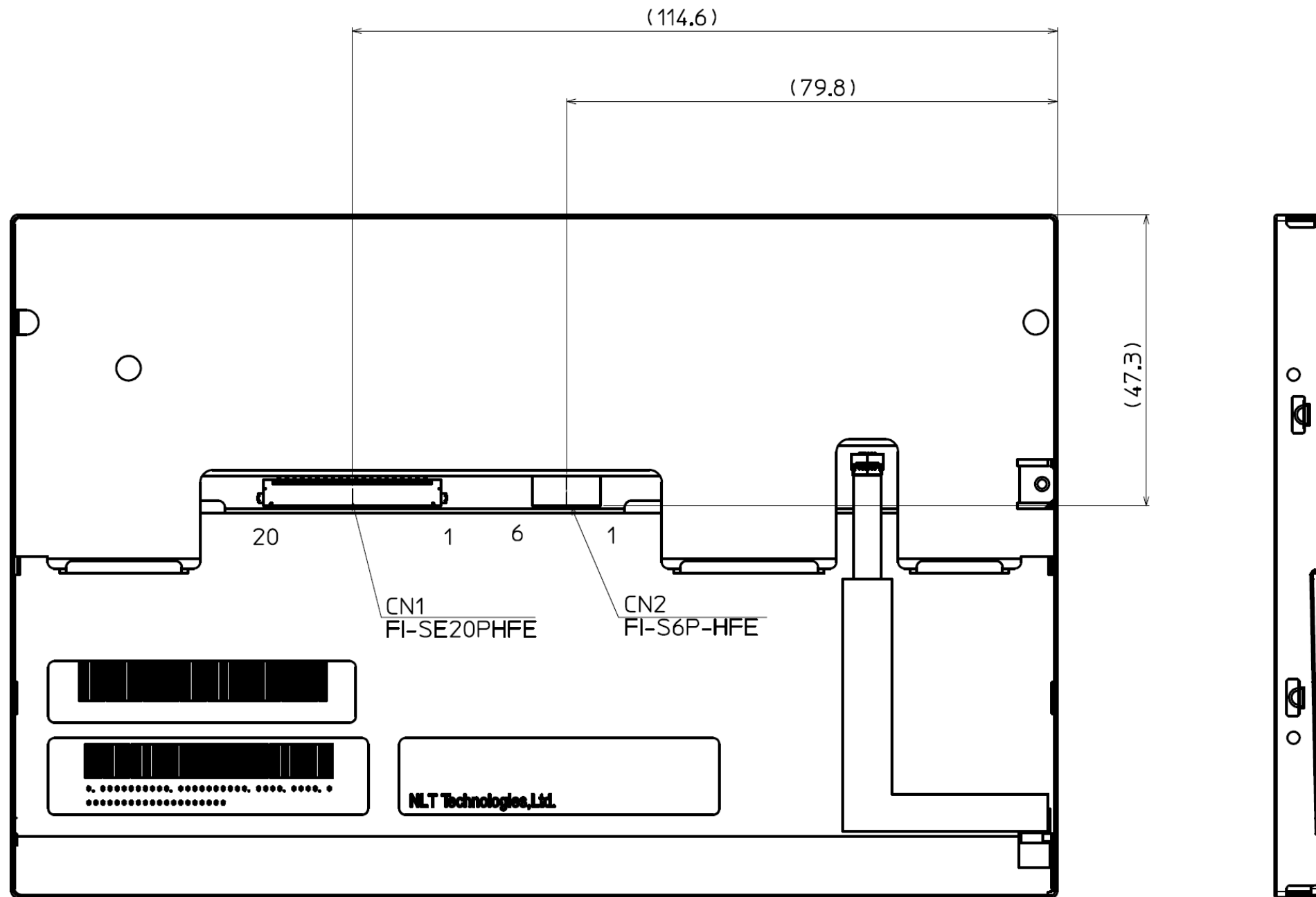

Unit: mm

Note1: The values in parentheses are for reference.

Note2: The torque for product mounting screws must never exceed 0.23 N·m. And the length of product mounting screws must be ≤ 2.0 mm.

REVISION HISTORY

The inside of latest specifications is revised to the clerical error and the major improvement of previous edition. Only a changed part such as functions, characteristic value and so on that may affect a design of customers, are described especially below.

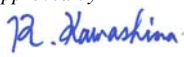
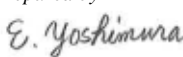
Edition	Document number	Prepared date	Revision contents and signature
1st edition	DOD-PP-1688	June 17, 2013	<p>Revision contents</p> <p>New issue</p> <p>Writer</p> <p>Approved by _____ R. KAWASHIMA</p> <p>Checked by _____ —</p> <p>Prepared by _____ E. YOSHIMURA</p>
2nd edition	DOD-PP-1762	Sep. 30, 2013	<p>Revision contents</p> <p>P5 General specifications</p> <ul style="list-style-type: none"> • Module size: (8.5) (D) mm (typ.) → 8.5 (D) mm (typ.) • Contrast ratio: (600):1 (typ.) → (800):1 (typ.) <p>P6 Block diagram</p> <ul style="list-style-type: none"> • VDD – BRTC: TBD kΩ → 10 kΩ • VDD – PWM: TBD kΩ → 10 kΩ <p>P7 Mechanical specifications</p> <ul style="list-style-type: none"> • Module size: (8.5) ± 0.5 mm → 8.5 ± 0.5 mm <p>P8 Electrical characteristics – LCD panel signal processing board</p> <ul style="list-style-type: none"> • Power supply current: TBD (typ., max.) mA → (160) (typ.), (250) (max.) mA <p>P9 Fuse (Specified)</p> <p>P19 Optics – Optical characteristics</p> <ul style="list-style-type: none"> • Luminance: (600) (min.) cd/m² → 600 (min.) cd/m² • Contrast ratio: (400) (min.), (600) (typ.) → (500) (min.), (800) (typ.) <p>P25 Outline drawing - Front view (Updated)</p> <p>P26 Outline drawing - Rear view (Specified)</p> <p>Signature of writer</p> <p>Approved by  _____ R. KAWASHIMA</p> <p>Checked by _____ _____</p> <p>Prepared by  _____ E. YOSHIMURA</p>