

# TFT COLOR LCD MODULE

**NL6448BC18-06F**

**15cm (5.7 Type)  
VGA**

**DATA SHEET**   
**DOD-PP-1099 (1st edition)**

**This DATA SHEET is updated document from  
PRELIMINARY DATA SHEET DOD-PP-0995(1).**

**All information is subject to change without notice.  
Please confirm the sales representative before  
starting to design your system.**

---

## INTRODUCTION

The Copyright to this document belongs to NEC LCD Technologies, Ltd. (hereinafter called "NEC"). No part of this document will be used, reproduced or copied without prior written consent of NEC.

NEC does and will not assume any liability for infringement of patents, copyrights or other intellectual property rights of any third party arising out of or in connection with application of the products described herein except for that directly attributable to mechanisms and workmanship thereof. No license, express or implied, is granted under any patent, copyright or other intellectual property right of NEC.

Some electronic parts/components would fail or malfunction at a certain rate. In spite of every effort to enhance reliability of products by NEC, the possibility of failures and malfunction might not be avoided entirely. To prevent the risks of damage to death, human bodily injury or other property arising out thereof or in connection therewith, each customer is required to take sufficient measures in its safety designs and plans including, but not limited to, redundant system, fire-containment and anti-failure.

The products are classified into three quality grades: "**Standard**", "**Special**", and "**Specific**" of the highest grade of a quality assurance program at the choice of a customer. Each quality grade is designed for applications described below. Any customer who intends to use a product for application other than that of Standard quality grade is required to contact an NEC sales representative in advance.

The **Standard** quality grade applies to the products developed, designed and manufactured in accordance with the NEC standard quality assurance program, which are designed for such application as any failure or malfunction of the products (sets) or parts/components incorporated therein a customer uses are, directly or indirectly, free of any damage to death, human bodily injury or other property, like general electronic devices.

Examples: Computers, office automation equipment, communications equipment, test and measurement equipment, audio and visual equipment, home electronic appliances, machine tools, personal electronic equipment, industrial robots, etc.

The **Special** quality grade applies to the products developed, designed and manufactured in accordance with an NEC quality assurance program stricter than the standard one, which are designed for such application as any failure or malfunction of the products (sets) or parts/components incorporated therein a customer uses might directly cause any damage to death, human bodily injury or other property, or such application under more severe condition than that defined in the Standard quality grade without such direct damage.

Examples: Control systems for transportation equipment (automobiles, trains, ships, etc.), traffic control systems, anti-disaster systems, anti-crime systems, medical equipment not specifically designed for life support, safety equipment, etc.

The **Specific** quality grade applies to the products developed, designed and manufactured in accordance with the standards or quality assurance program designated by a customer who requires an extremely higher level of reliability and quality for such products.

Examples: Military systems, aircraft control equipment, aerospace equipment, nuclear reactor control systems, medical equipment/devices/systems for life support, etc.

The quality grade of this product is the "**Standard**" unless otherwise specified in this document.

**CONTENTS**

**INTRODUCTION** ..... 2

**1. OUTLINE** ..... 4

    1.1 STRUCTURE AND PRINCIPLE ..... 4

    1.2 APPLICATION ..... 4

    1.3 FEATURES ..... 4

**2. GENERAL SPECIFICATIONS** ..... 5

**3. BLOCK DIAGRAM** ..... 6

**4. DETAILED SPECIFICATIONS** ..... 8

    4.1 MECHANICAL SPECIFICATIONS ..... 8

    4.2 ABSOLUTE MAXIMUM RATINGS ..... 8

    4.3 ELECTRICAL CHARACTERISTICS ..... 9

        4.3.1 LCD panel signal processing board ..... 9

        4.3.2 Backlight ..... 10

        4.3.3 Power supply voltage ripple ..... 10

        4.3.4 Fuse ..... 10

    4.4 POWER SUPPLY VOLTAGE SEQUENCE ..... 11

        4.4.1 LCD panel signal processing board ..... 11

        4.4.2 LED driver board ..... 11

    4.5 CONNECTIONS AND FUNCTIONS FOR INTERFACE PINS ..... 12

        4.5.1 LCD panel signal processing board ..... 12

        4.5.2 Backlight ..... 13

        4.5.3 Positions of plug and socket ..... 13

    4.6 DISPLAY COLORS AND INPUT DATA SIGNALS ..... 14

    4.7 DISPLAY POSITIONS AND SCANNING DIRECTIONS ..... 15

        4.7.1 Setting the LCD module in the landscape position (horizontal) ..... 15

        4.7.2 Setting the LCD module in the portrait position (vertical) ..... 16

    4.8 INPUT SIGNAL TIMINGS ..... 17

        4.8.1 Outline of input signal timings ..... 17

        4.8.2 Timing characteristics ..... 18

        4.8.3 Input signal timing chart ..... 20

    4.9 OPTICS ..... 23

        4.9.1 Optical characteristics ..... 23

        4.9.2 Definition of contrast ratio ..... 24

        4.9.3 Definition of luminance uniformity ..... 24

        4.9.4 Definition of response times ..... 24

        4.9.5 Definition of viewing angles ..... 24

**5. ESTIMATED LUMINANCE LIFETIME** ..... 25

**6. RELIABILITY TESTS** ..... 26

**7. PRECAUTIONS** ..... 27

    7.1 MEANING OF CAUTION SIGNS ..... 27

    7.2 CAUTIONS ..... 27

    7.3 ATTENTIONS ..... 27

        7.3.1 Handling of the product ..... 27

        7.3.2 Environment ..... 28

        7.3.3 Characteristics ..... 28

        7.3.4 Others ..... 28

**8. OUTLINE DRAWINGS** ..... 29

**1. OUTLINE**

**1.1 STRUCTURE AND PRINCIPLE**

Color LCD module NL6448BC18-06F is composed of the amorphous silicon thin film transistor liquid crystal display (a-Si TFT LCD) panel structure with driver LSIs for driving the TFT (Thin Film Transistor) array and a backlight.

The a-Si TFT LCD panel structure is injected liquid crystal material into a narrow gap between the TFT array glass substrate and a color-filter glass substrate.

Color (Red, Green, Blue) data signals from a host system (e.g. signal generator, etc.) are modulated into best form for active matrix system by a signal processing board, and sent to the driver LSIs which drive the individual TFT arrays.

The TFT array as an electro-optical switch regulates the amount of transmitted light from the backlight assembly, when it is controlled by data signals. Color images are created by regulating the amount of transmitted light through the TFT array of red, green and blue dots.

**1.2 APPLICATION**

- For industrial use

**1.3 FEATURES**

- High luminance
- High contrast
- Wide viewing angle
- Wide temperature range
- 6-bit digital RGB signals
- Reversible-scan direction
- LED Backlight type
- Replaceable lamp for backlight
- Suitable for setting in the portrait position (See "**4.7.2 Setting the LCD module in the portrait position (vertical)**"). ☆
- Acquisition product for UL60950-1/CSA C22.2 No.60950-1-03 (File number: E170632)
- Compliant with the European RoHS directive (2002/95/EC)

Display setting difference between NL6448BC18-06F and NL6448BC18-03F ☆

Item	NL6448BC18-06F	NL6448BC18-03F
LCD panel signal processing board: CN1 socket	502790-4091 (Molex Japan Co., Ltd.) Pin No. 1 to 40	08 6260 033 340 829+ (Kyocera Elco Corp.) Pin No. 1 to 33

2. GENERAL SPECIFICATIONS

<b>Display area</b>	116.16 (H) × 87.12 (V) mm
<b>Diagonal size of display</b>	15cm (5.7inches)
<b>Drive system</b>	a-Si TFT active matrix
<b>Display color</b>	262,144 colors
<b>Pixel</b>	640 (H) × 480 (V) pixels
<b>Pixel arrangement</b>	RGB (Red dot, Green dot, Blue dot) vertical stripe
<b>Dot pitch</b>	0.0605 (H) × 0.1815 (V) mm
<b>Pixel pitch</b>	0.1815 (H) × 0.1815 (V) mm
<b>Module size</b>	135.0 (W) × 104.6 (H) × 10.5 (D) mm (typ.)
<b>Weight</b>	165g (typ.)
<b>Contrast ratio</b>	850:1 (typ.)
<b>Viewing angle</b>	At the contrast ratio $\geq 10:1$ <ul style="list-style-type: none"> <li>• Horizontal: Right side 80° (typ.), Left side 80° (typ.)</li> <li>• Vertical: Up side 80° (typ.), Down side 80° (typ.)</li> </ul>
<b>Designed viewing direction</b>	At <i>DPSH= Low or Open, DPSV= High or Open: Normal scan</i> <ul style="list-style-type: none"> <li>• Viewing direction without image reversal: Right side (3 o'clock)</li> <li>• Viewing direction with contrast peak: Left side (9 o'clock)</li> <li>• Viewing angle with optimum grayscale (<math>\gamma=2.2</math>): Normal axis (perpendicular)</li> </ul>
<b>Polarizer surface</b>	Clear
<b>Polarizer pencil-hardness</b>	3H (min.) [by JIS K5600]
<b>Color gamut</b>	At LCD panel center 60% (typ.) [against NTSC color space]
<b>Response time</b>	<i>Ton+Toff (10% ←→ 90%)</i> 18ms (typ.)
<b>Luminance</b>	At <i>IL= 25mA / One circuit</i> 800cd/m <sup>2</sup> (typ.)
<b>Signal system</b>	6-bit digital signals for data of RGB colors, Dot clock (CLK), Data enable (DE), Horizontal synchronous signal (Hsync), Vertical synchronous signal (Vsync)
<b>Power supply voltage</b>	LCD panel signal processing board: 3.3V
<b>Backlight</b>	LED backlight type  <div style="border-left: 1px solid black; border-right: 1px solid black; padding: 0 10px;">                     Replaceable part                     <ul style="list-style-type: none"> <li>• Lamp holder set: Type No. 57LHS02</li> </ul> </div>
<b>Power consumption</b>	At <i>IL= 25mA / One circuit, Checkered flag pattern</i> 3.3W (typ.)

☆

☆

3. BLOCK DIAGRAM

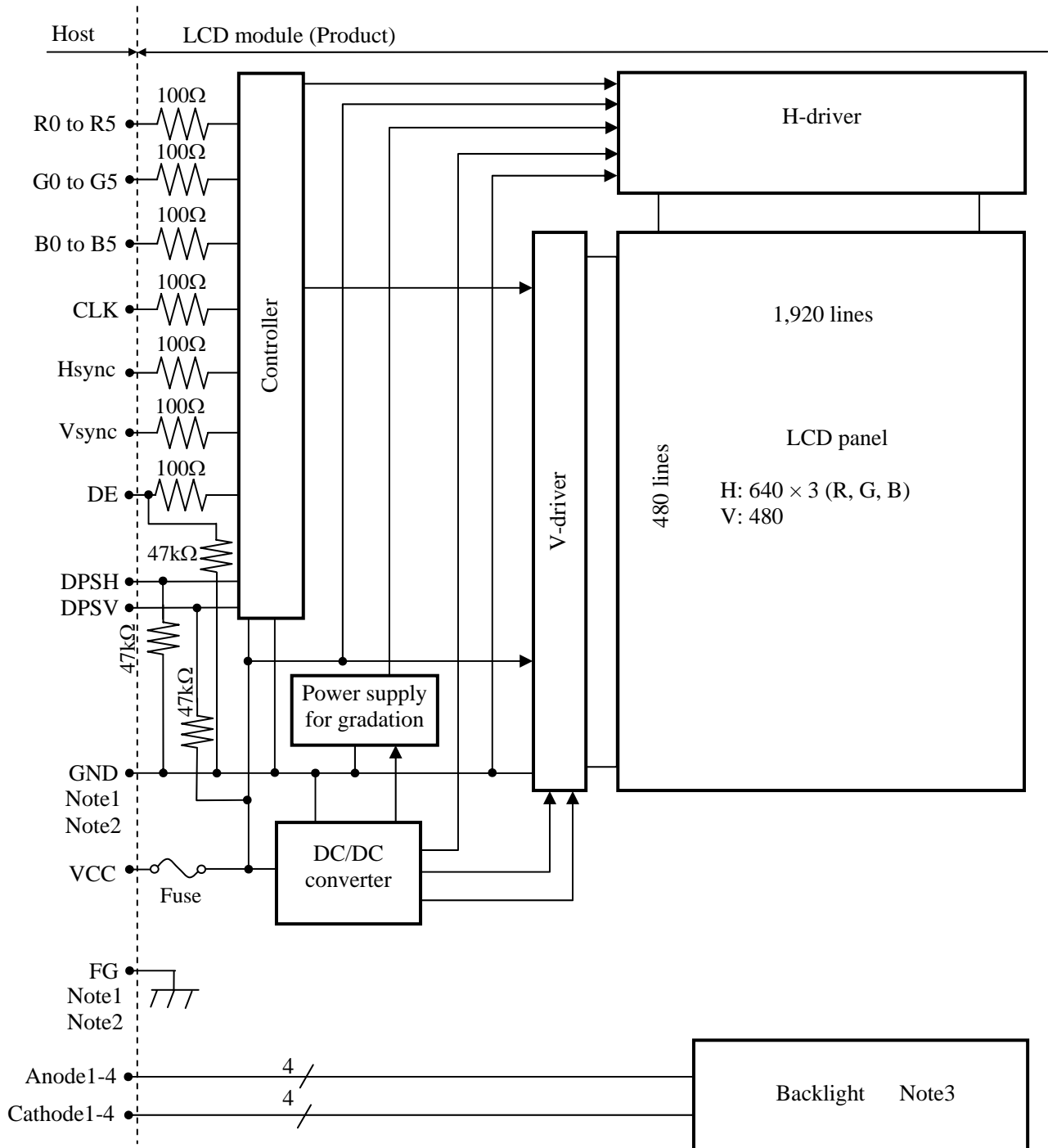

Note1: Relations between GND (Signal ground) and FG (Frame ground) in the LCD module are as follows.

GND - FG	Not Connected
----------	---------------

Note2: GND and FG must be connected to customer equipment's ground, and it is recommended that these grounds be connected together in customer equipment.

Note3: Backlight in detail

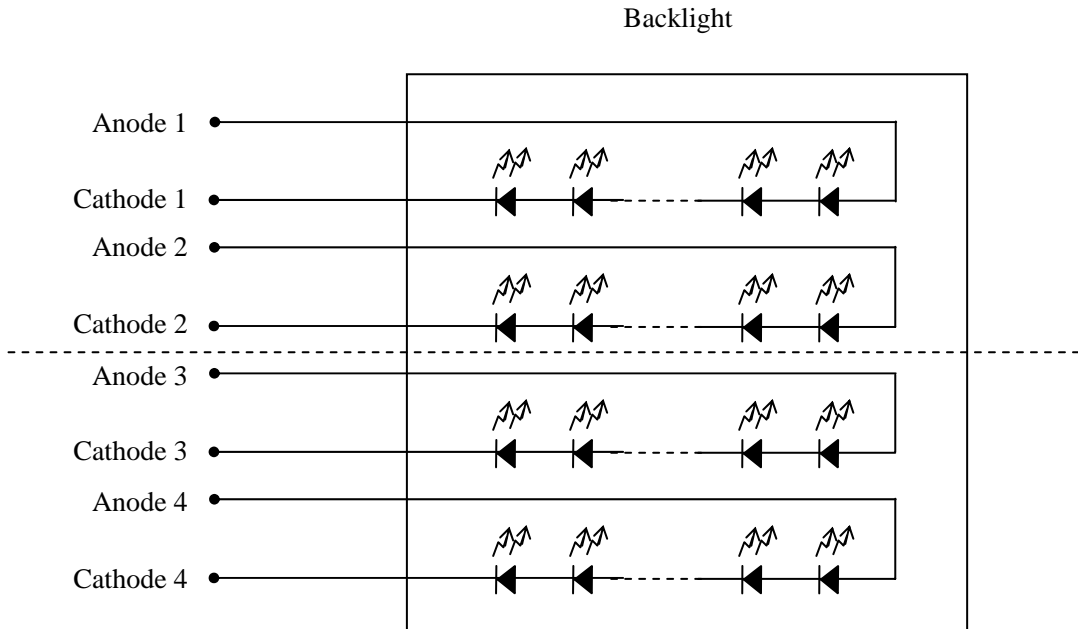

**4. DETAILED SPECIFICATIONS**

**4.1 MECHANICAL SPECIFICATIONS**

Parameter	Specification	Unit
Module size	135 ± 0.5 (W) × 104.6 ± 0.5 (H) × 10.5 ± 0.5 (D) Note1	mm
Display area	116.16 (H) × 87.12 (V) Note1	mm
Weight	165 (typ.), 175 (max.)	g



Note1: See "8. OUTLINE DRAWINGS".

**4.2 ABSOLUTE MAXIMUM RATINGS**

Parameter		Symbol	Rating	Unit	Remarks
Power supply voltage	LCD panel signal processing board	VCC	-0.3 to +6.5	V	-
Input voltage for signals	Display signals Note1	VD	-0.3 to VCC +0.3	V	-
	Function signals Note2	VF			
Backlight	Forward current	IL	Note3	mA	per one circuit
Storage temperature		Tst	-30 to +80	°C	-
Operating temperature	Front surface	TopF	-30 to +80	°C	Note4
	Rear surface	TopR	-30 to +80	°C	Note5
Relative humidity Note6		RH	≤ 95	%	Ta ≤ 40°C
			≤ 85	%	40 < Ta ≤ 50°C
			≤ 55	%	50°C < Ta ≤ 60°C
			≤ 36	%	60°C < Ta ≤ 70°C
			≤ 24	%	70°C < Ta ≤ 80°C
Absolute humidity Note6		AH	≤ 70 Note7	g/m <sup>3</sup>	Ta > 80°C

Note1: CLK, Hsync, Vsync, DE, DATA (R0 to R5, G0 to G5, B0 to B5)

Note2: DPSH, DPSV



Note3: Forward current

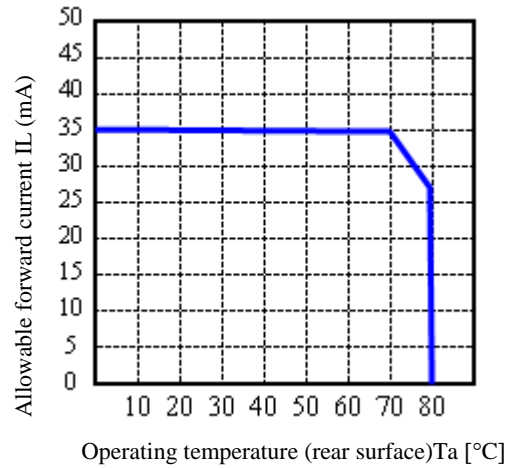

- Note4: Measured at center of LCD panel surface (including self-heat) ☆
- Note5: Measured at center of LCD module's rear shield surface (including self-heat) ☆
- Note6: No condensation
- Note7: Water amount at Ta= 80°C and RH= 24%

4.3 ELECTRICAL CHARACTERISTICS

4.3.1 LCD panel signal processing board

(Ta= 25°C)

Parameter	Symbol	min.	typ.	max.	Unit	Remarks
Power supply voltage	VCC	3.0	3.3	3.6	V	-
Power supply current	ICC	-	100 Note1	175 Note2	mA	at VCC= 3.3V
Logic input voltage for display signals	High	VDH	0.7VCC	-	VCC	CMOS level
	Low	VDL	0	-	0.3VCC	
Input voltage for DPSH and DPSV signal	High	VFH	0.7VCC	-	VCC	
	Low	VFL	0	-	0.3VCC	

Note1: Checkered flag pattern [by EIAJ ED-2522]

Note2: Pattern for maximum current

4.3.2 Backlight

(Ta=25°C, Note1, Note2)

Parameter	Symbol	min.	typ.	max.	Unit	Remarks
Forward current	IL	-	25	27.5	mA	Note3
Forward Voltage	VL	-	29.7	34.2	V	at IL= 25mA / One circuit

Note1: Please drive with constant current.

Note2: The Luminance uniformity may be changed depending on the current variation between 4 circuits. It is recommended that the current value difference among the circuits be less than 5%.

Note3: See "**4.2 ABSOLUTE MAXIMUM RATINGS Note3**".

4.3.3 Power supply voltage ripple

This product works if the ripple voltage levels are over the permissible values as the following table, but there might be noise on the display image.

Power supply voltage	Ripple voltage (Measure at input terminal of power supply)	Note1	Unit
VCC	3.3V	≤ 100	mVp-p

Note1: The permissible ripple voltage includes spike noise.

4.3.4 Fuse

Parameter	Fuse		Rating	Fusing current	Remarks
	Type	Supplier			
VCC	3216FF-1A	COOPER Bussmann	1A	2.5A	Note1
			63V (DC)		

Note1: The power supply's rated current must be more than the fusing current. If it is less than the fusing current, the fuse may not blow in a short time, and then nasty smell, smoke and so on may occur.

4.4 POWER SUPPLY VOLTAGE SEQUENCE

4.4.1 LCD panel signal processing board

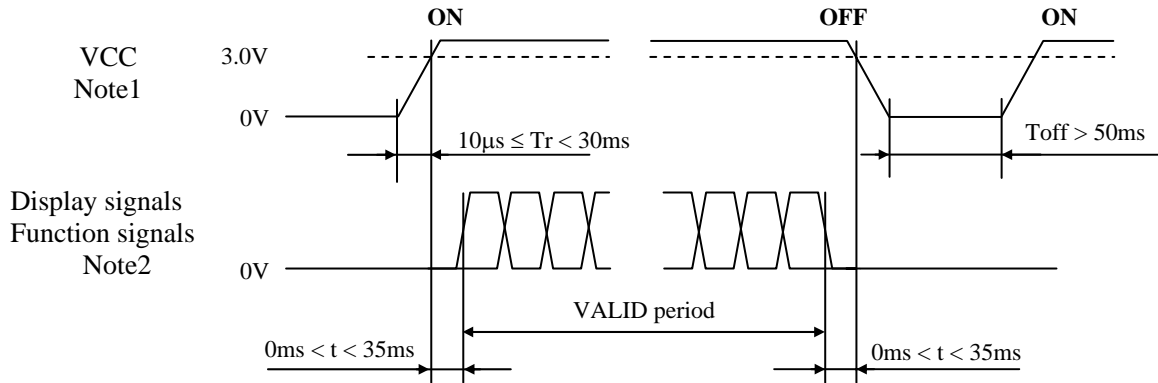

Note1: If there is a voltage variation (voltage drop) at the rising edge of VCC below 3.0V, there is a possibility that a product does not work due to a protection circuit.

Note2: Display signals (CLK, Hsync, Vsync, DE, DATA (R0 to R5, G0 to G5, B0 to B5)) and function signals (DPSH, DPSV) must be set to Low or High-impedance, except the VALID period (See above sequence diagram), in order to avoid the circuitry damage.

If some of display and function signals of this product are cut while this product is working, even if the signal input to it once again, it might not work normally. If a customer stops the display and function signals, VCC also must be shut down.

4.4.2 LED driver board

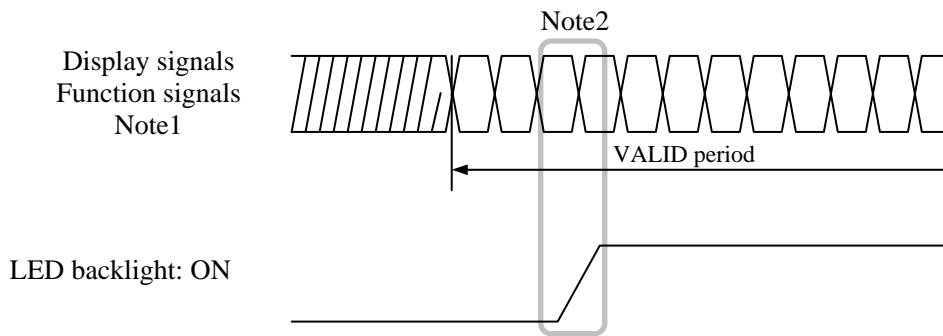

Note1: These are the display and function signals for LCD panel signal processing board.

Note2: The backlight should be turned on within the valid period of display and function signals, in order to avoid unstable data display.

4.5 CONNECTIONS AND FUNCTIONS FOR INTERFACE PINS

4.5.1 LCD panel signal processing board

CN1 socket (LCD module side): 502790-4091 (Molex Japan Co., Ltd.)

Adaptable plug: [0.5mm pitch, Bottom Contact Type]

Pin No.	Symbol	Signal	Remarks
1	GND	Ground	Note1
2	CLK	Dot clock	-
3	Hsync	Horizontal synchronous signal	
4	Vsync	Vertical synchronous signal	
5	GND	Ground	Note1
6	R0	Red data (LSB)	Least significant bit
7	R1	Red data	-
8	R2	Red data	
9	R3	Red data	
10	R4	Red data	
11	R5	Red data (MSB)	Most significant bit
12	GND	Ground	Note1
13	G0	Green data (LSB)	Least significant bit
14	G1	Green data	-
15	G2	Green data	
16	G3	Green data	
17	G4	Green data	
18	G5	Green data (MSB)	Most significant bit
19	GND	Ground	Note1
20	B0	Blue data (LSB)	Least significant bit
21	B1	Blue data	-
22	B2	Blue data	
23	B3	Blue data	
24	B4	Blue data	
25	B5	Blue data (MSB)	Most significant bit
26	GND	Ground	Note1
27	DE	Selection of DE / Fixed mode	Low or Open: Fixed mode Data enable signal: DE mode
28	VCC	Power supply	Note1
29	VCC	Power supply	
30	DPSH	Selection of Horizontal scan direction	High: Reverse scan Low or Open: Normal scan Note2
31	DPSV	Selection of Vertical scan direction	High or Open: Normal scan Low: Reverse scan Note2
32	N. C.	-	Keep this pin Open.
33	GND	Ground	Note1
34 - 40	N. C.	-	Keep these pins Open.

Note1: All GND and VCC terminals should be used without any non-connected lines.

Note2: See "4.7 DISPLAY POSITIONS AND SCANNING DIRECTIONS"

4.5.2 Backlight

CN2 plug (LCD module side): SM08B-SRSS-TB (J.S.T. Mfg. Co., Ltd.)

Adaptable socket: SHR-08V-S, SHR-08V-S-B (J.S.T. Mfg. Co., Ltd.)

☆

Pin No.	Symbol	Signal	Remarks
1	A1	Anode1	-
2	K1	Cathode1	-
3	A2	Anode2	-
4	K2	Cathode2	-
5	N.C.	-	Keep this pin Open.
6	N.C.	-	Keep this pin Open.
7	N.C.	-	Keep this pin Open.
8	N.C.	-	Keep this pin Open.

CN3 plug (LCD module side): SM08B-SRSS-TB (J.S.T. Mfg. Co., Ltd.)

Adaptable socket: SHR-08V-S, SHR-08V-S-B (J.S.T. Mfg. Co., Ltd.)

☆

Pin No.	Symbol	Signal	Remarks
1	A3	Anode3	-
2	K3	Cathode3	-
3	A4	Anode4	-
4	K4	Cathode4	-
5	N. C.	-	Keep this pin Open.
6	N. C.	-	Keep this pin Open.
7	N. C.	-	Keep this pin Open.
8	N. C.	-	Keep this pin Open.

4.5.3 Positions of plug and socket

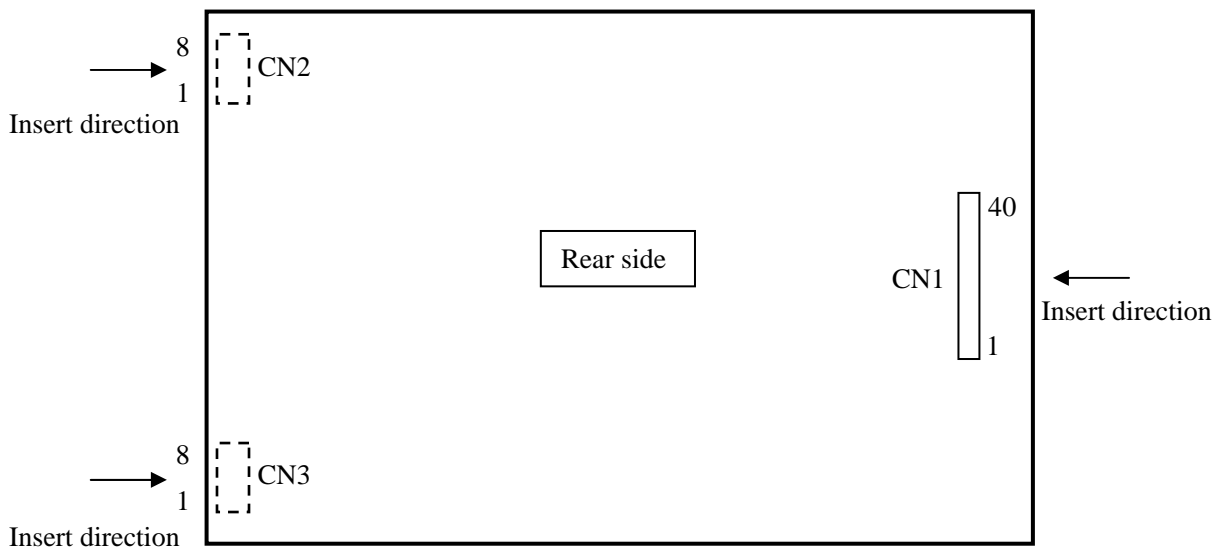

4.6 DISPLAY COLORS AND INPUT DATA SIGNALS

This product can display 262,144 colors with 64 gray scales. Also the relation between display colors and input data signals is as follows.

Display colors		Data signal (0: Low level, 1: High level)																	
		R5	R4	R3	R2	R1	R0	G5	G4	G3	G2	G1	G0	B5	B4	B3	B2	B1	B0
Basic colors	Black	0	0	0	0	0	0	0	0	0	0	0	0	0	0	0	0	0	0
	Blue	0	0	0	0	0	0	0	0	0	0	0	0	1	1	1	1	1	1
	Red	1	1	1	1	1	1	0	0	0	0	0	0	0	0	0	0	0	0
	Magenta	1	1	1	1	1	1	0	0	0	0	0	0	1	1	1	1	1	1
	Green	0	0	0	0	0	0	1	1	1	1	1	1	0	0	0	0	0	0
	Cyan	0	0	0	0	0	0	1	1	1	1	1	1	1	1	1	1	1	1
	Yellow	1	1	1	1	1	1	1	1	1	1	1	1	0	0	0	0	0	0
	White	1	1	1	1	1	1	1	1	1	1	1	1	1	1	1	1	1	1
Red gray scale	Black	0	0	0	0	0	0	0	0	0	0	0	0	0	0	0	0	0	0
	dark	0	0	0	0	0	1	0	0	0	0	0	0	0	0	0	0	0	0
	↑				:						:					:			
	↓				:						:					:			
	bright	1	1	1	1	0	1	0	0	0	0	0	0	0	0	0	0	0	0
Red	1	1	1	1	1	1	0	0	0	0	0	0	0	0	0	0	0	0	
Green gray scale	Black	0	0	0	0	0	0	0	0	0	0	0	0	0	0	0	0	0	0
	dark	0	0	0	0	0	0	0	0	0	0	1	0	0	0	0	0	0	0
	↑				:						:					:			
	↓				:						:					:			
	bright	0	0	0	0	0	0	1	1	1	1	0	1	0	0	0	0	0	0
Green	0	0	0	0	0	0	1	1	1	1	1	1	0	0	0	0	0	0	
Blue gray scale	Black	0	0	0	0	0	0	0	0	0	0	0	0	0	0	0	0	0	0
	dark	0	0	0	0	0	0	0	0	0	0	0	0	0	0	0	0	1	0
	↑				:						:					:			
	↓				:						:					:			
	bright	0	0	0	0	0	0	0	0	0	0	0	0	1	1	1	1	0	1
Blue	0	0	0	0	0	0	0	0	0	0	0	0	1	1	1	1	1	0	
Blue	0	0	0	0	0	0	0	0	0	0	0	0	1	1	1	1	1	1	

4.7 DISPLAY POSITIONS AND SCANNING DIRECTIONS

4.7.1 Setting the LCD module in the landscape position (horizontal)

(1) Display positions

The following table is the coordinates per pixel (See "4.7.1 (2) Scanning directions").

C( 0, 0)	C( 1, 0)	...	C( X, 0)	...	C(638, 0)	C(639, 0)
C( 0, 1)	C( 1, 1)	...	C( X, 1)	...	C(638, 1)	C(639, 1)
•	•	•	•	•	•	•
•	•	•••	•	•••	•	•••
•	•	•	•	•	•	•
C( 0, Y)	C( 1, Y)	...	C( X, Y)	...	C(638, Y)	C(639, Y)
•	•	•	•	•	•	•
•	•	•••	•	•••	•	•
•	•	•	•	•	•	•
C( 0, 478)	C( 1, 478)	...	C( X, 478)	...	C(638, 478)	C(639, 478)
C( 0, 479)	C( 1, 479)	...	C( X, 479)	...	C(638, 479)	C(639, 479)

(2) Scanning directions

The following figures are seen from a front view. Also the arrow shows the direction of scan.

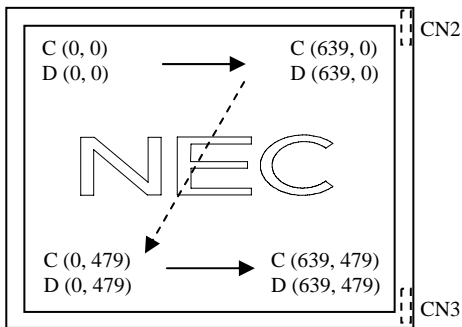

Figure1. DPSH= Low or Open (Normal scan)  
DPSV= High or Open (Normal scan)

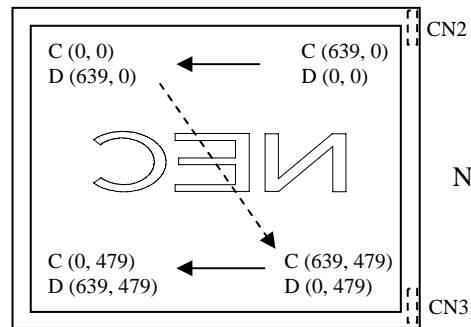

Figure2. DPSH= High (Reverse scan)  
DPSV= High or Open (Normal scan)

Note1

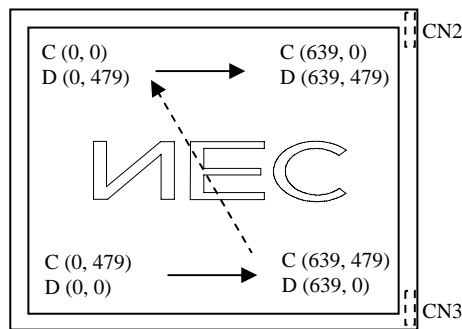

Figure3. DPSH= Low or Open (Normal scan)  
DPSV= Low (Reverse scan)

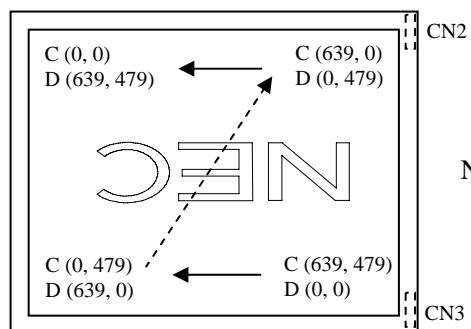

Figure4. DPSH= High (Reverse scan)  
DPSV= Low (Reverse scan)

Note1

Note1: Meaning of C (X, Y) and D (X, Y)

C (X, Y): The coordinates of the display position (See "4.7 1 (1) Display positions".)

D (X, Y): The data number of input signal for LCD panel signal processing board

4.7.2 Setting the LCD module in the portrait position (vertical)

(1) Display positions

The following table is the coordinates per pixel (See figure of "4.7.2 (2) Scanning directions".).

C(639, 0)	C(639, 1)	...	C(639, Y)	...	C(639,478)	C(639,479)
C(638, 0)	C(638, 1)	...	C(638, Y)	...	C(638,478)	C(638,479)
•	•	•	•	•	•	•
•	•	•	•	•	•	•
•	•	•	•	•	•	•
C( X, 0)	C( X, 1)	...	C( X, Y)	...	C( X,478)	C( X,479)
•	•	•	•	•	•	•
•	•	•	•	•	•	•
•	•	•	•	•	•	•
C( 1, 0)	C( 1, 1)	...	C( 1, Y)	...	C( 1,478)	C( 1,479)
C( 0, 0)	C( 0, 1)	...	C( 0, Y)	...	C( 0, 478)	C( 0,479)

(2) Scanning directions

The following figures are seen from a front view. Also the arrow shows the direction of scan.

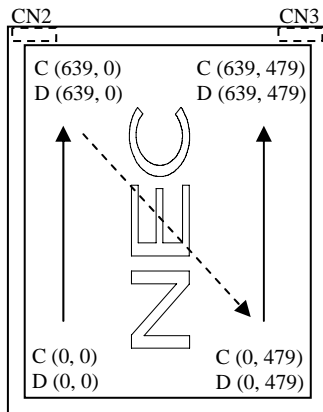

Figure1. DPSH= Low or Open (Normal scan)  
DPSV= High or Open (Normal scan)

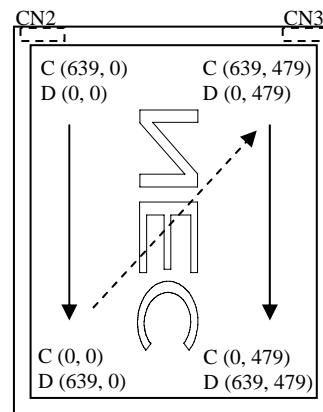

Figure2. DPSH= High (Reverse scan)  
DPSV= High or Open (Normal scan)

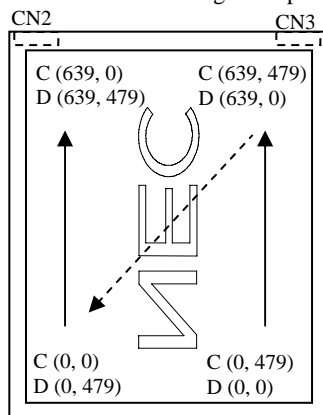

Figure3. DPSH= Low or Open (Normal scan)  
DPSV= Low (Reverse scan)

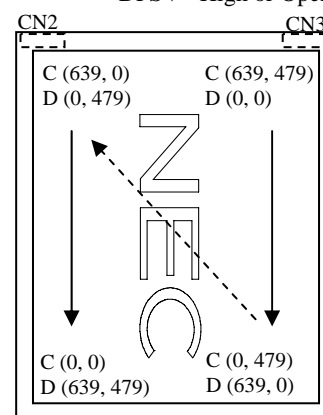

Figure4. DPSH= High (Reverse scan)  
DPSV= Low (Reverse scan)

Note1: Meaning of C (X, Y) and D (X, Y)

C (X, Y): The coordinates of the display position (See "4.7.2 (1) Display positions".)

D (X, Y): The data number of input signal for LCD panel signal processing board



4.8 INPUT SIGNAL TIMINGS

4.8.1 Outline of input signal timings

• Horizontal signal

Note1

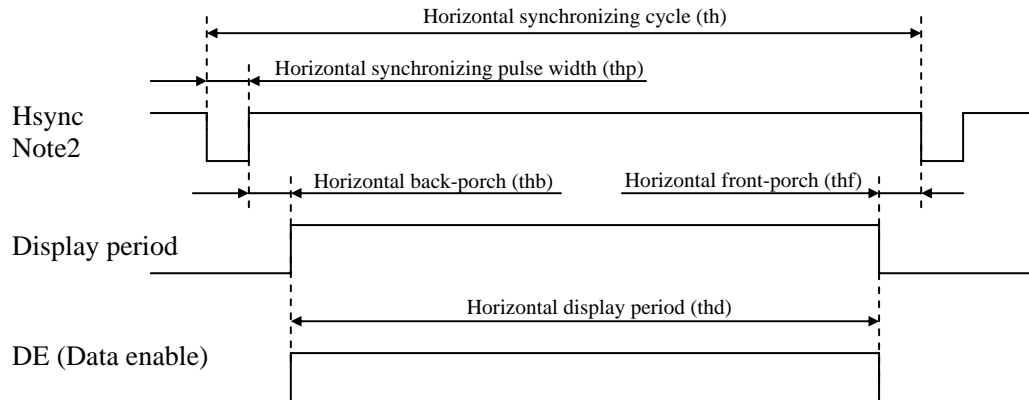

• Vertical signal

Note1

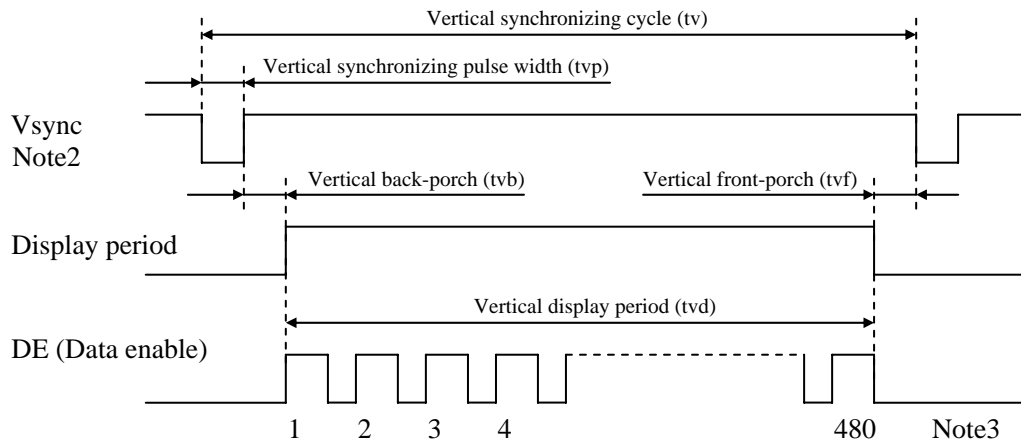

Note1: This diagram indicates virtual signal for set up to timing.

Note2: Fixed mode cannot be used while working of DE mode.

Note3: See "4.8.3 Input signal timing chart" for the pulse number.

4.8.2 Timing characteristics

(a) Fixed mode

(Note1, Note3)

Parameter		Symbol	min.	typ.	max.	Unit	Remarks	
CLK	Frequency	1/tc	22.66	25.175	27.69	MHz	39.72ns (typ.)	
	Duty	tcd	0.4	0.5	0.6	-	-	
	Rise time, Fall time	trf	-	-	10	ns	-	
DATA (R0-R5) (G0-G5) (B0-B5)	CLK-DATA	Setup time	tds	10	-	-	ns	-
		Hold time	tdh	10	-	-	ns	-
	Rise time, Fall time	tdrf	-	-	10	ns	-	
Hsync	Cycle	th	30.0	31.778	33.6	μs	31.468kHz (typ.)	
			800			CLK	-	
	Display period	thd	640			CLK	-	
	Front-porch	thf	16			CLK	-	
	Pulse width	thp	10	96	-	CLK	-	
	Back-porch	thb	-	48	134	CLK	-	
	Total of pulse width and back-porch	thp + thb	144			CLK	Note2	
	CLK- Hsync	Setup time	ths	10	-	-	ns	-
Hold time		thh	10	-	-	ns	-	
Rise time, Fall time	thrf	-	-	10	ns	-		
Vsync	Cycle	tv	16.1	16.683	17.2	ms	59.94Hz (typ.)	
			525			H	-	
	Display period	tvd	480			H	-	
	Front-porch	tvf	12			H	-	
	Pulse width	tvp	1	3	-	H	-	
	Back-porch	tvb	-	32	34	H	-	
	Total of pulse width and back-porch	tvp + tvb	35			H	Note2	
	Hsync-Vsync	Setup time	tvhs	10	-	-	ns	-
Hold time		tvhh	10	-	-	ns	-	
Rise time, Fall time	tvrf	-	-	10	ns	-		

Note1: Definition of parameters is as follows.

tc= 1CLK, tcd= tch/tc, th= 1H

Note2: Keep tvp + tvb and thp + thb within the table. If it is out of specification, display position will be shifted to right/left side or up/down.

Note3: Vertical cycle (tv) should be specified in integral multiple of Horizontal cycle (th).

(b) DE mode

(Note1, Note2, Note3)

Parameter		Symbol	min.	typ.	max.	Unit	Remarks		
CLK	Frequency	1/tc	22.66	25.175	27.69	MHz	39.72ns (typ.)		
	Duty	tcd	0.4	0.5	0.6	-	-		
	Rise time, Fall time	terf	-	-	10	ns			
DATA (R0-R5) (G0-G5) (B0-B5)	CLK-DATA	Setup time	tds	10	-	-	ns	-	
		Hold time	tdh	10	-	-	ns		
	Rise time, Fall time	tdrf	-	-	10	ns			
DE	Horizontal	Cycle	th	30.0	31.778	33.6	μs	31.468kHz (typ.)	
				-	800	-	CLK	-	
		Display period	thd	640			CLK	-	
	Vertical (One frame)	Cycle	tv	16.1	16.683	17.2	ms	59.94Hz (typ.)	
				-	525	-	H	-	
	CLK-DE	Setup time	tdes	10	-	-	ns	-	
				Hold time	Tdeh	10	-		-
		Rise time, Fall time		tderf	-	-	10		ns

Note1: Definition of parameters is as follows.

tc= 1CLK, tcd= tch/tc, th= 1H

Note2: Hsync signal (CN1-Pin No.3) and Vsync signal (CN1-Pin No.4) are not used inside the product at DE mode, but these terminals are connected with "GND" to avoid the noise problem when unused.

Note3: Vertical cycle (tv) should be specified in integral multiple of Horizontal cycle (th).

4.8.3 Input signal timing chart

(a) Fixed mode

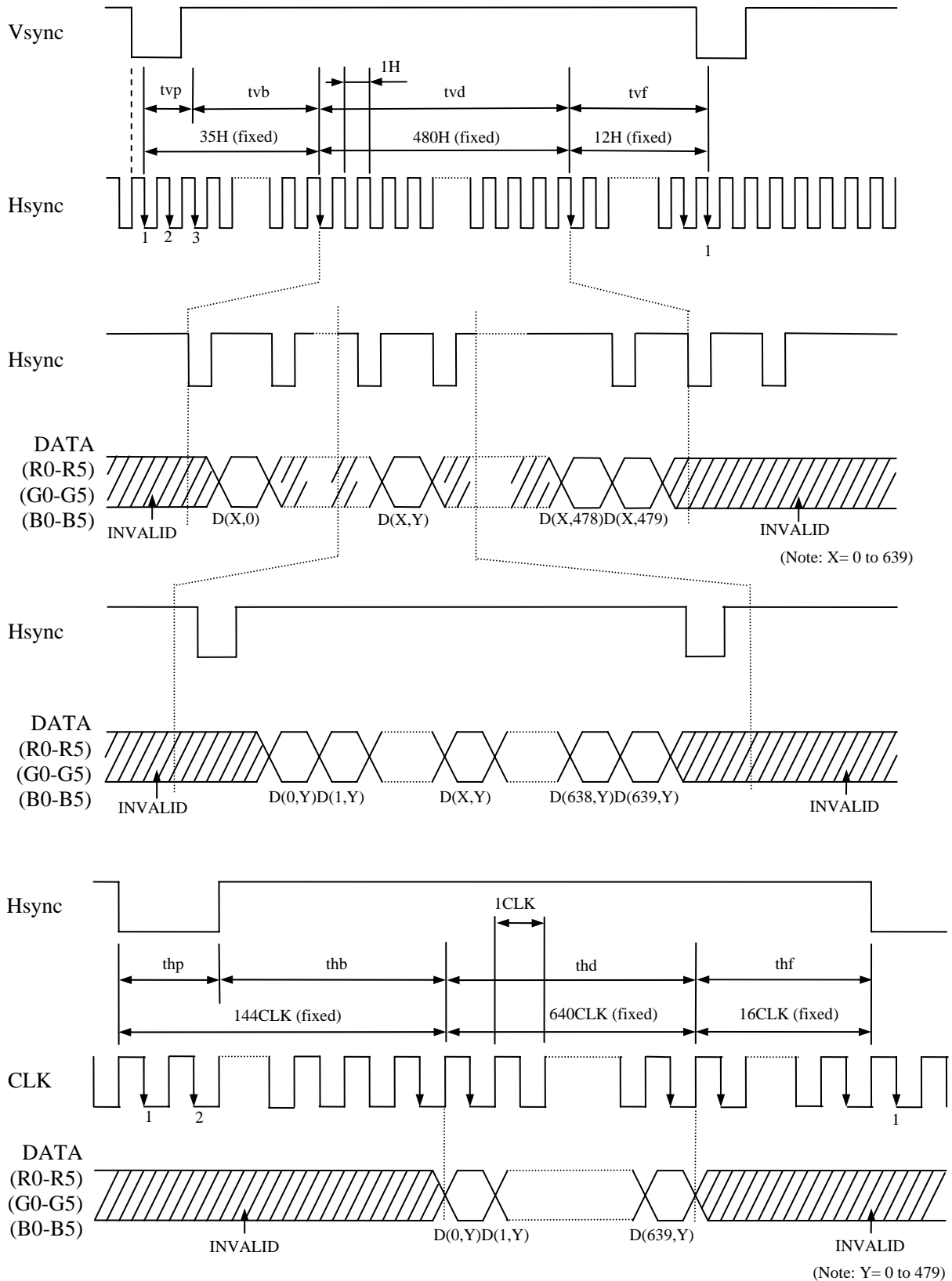

(b) DE mode

Horizontal timing

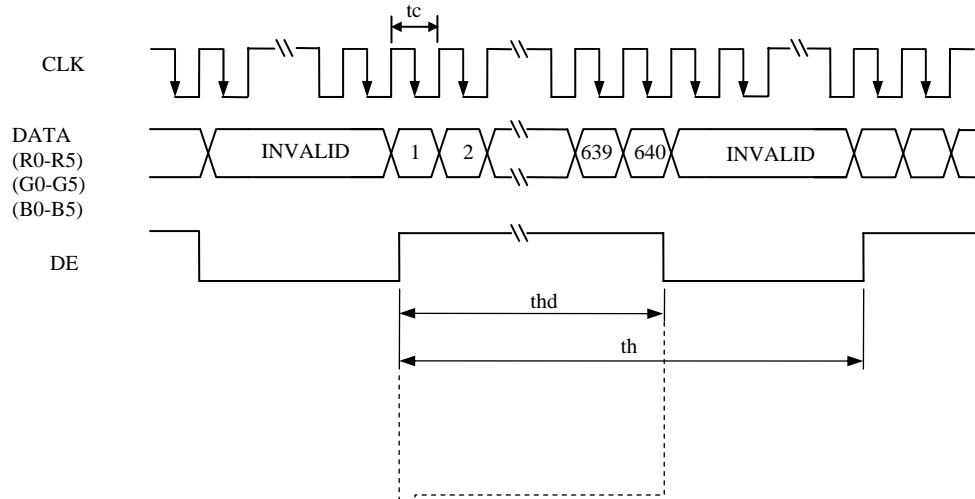

Vertical timing

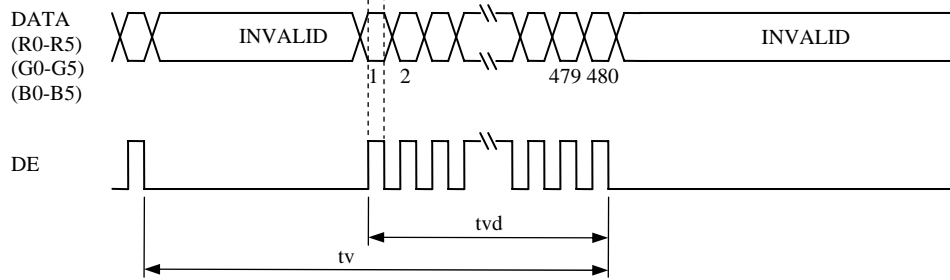

(c) Common item of Fixed mode and DE mode

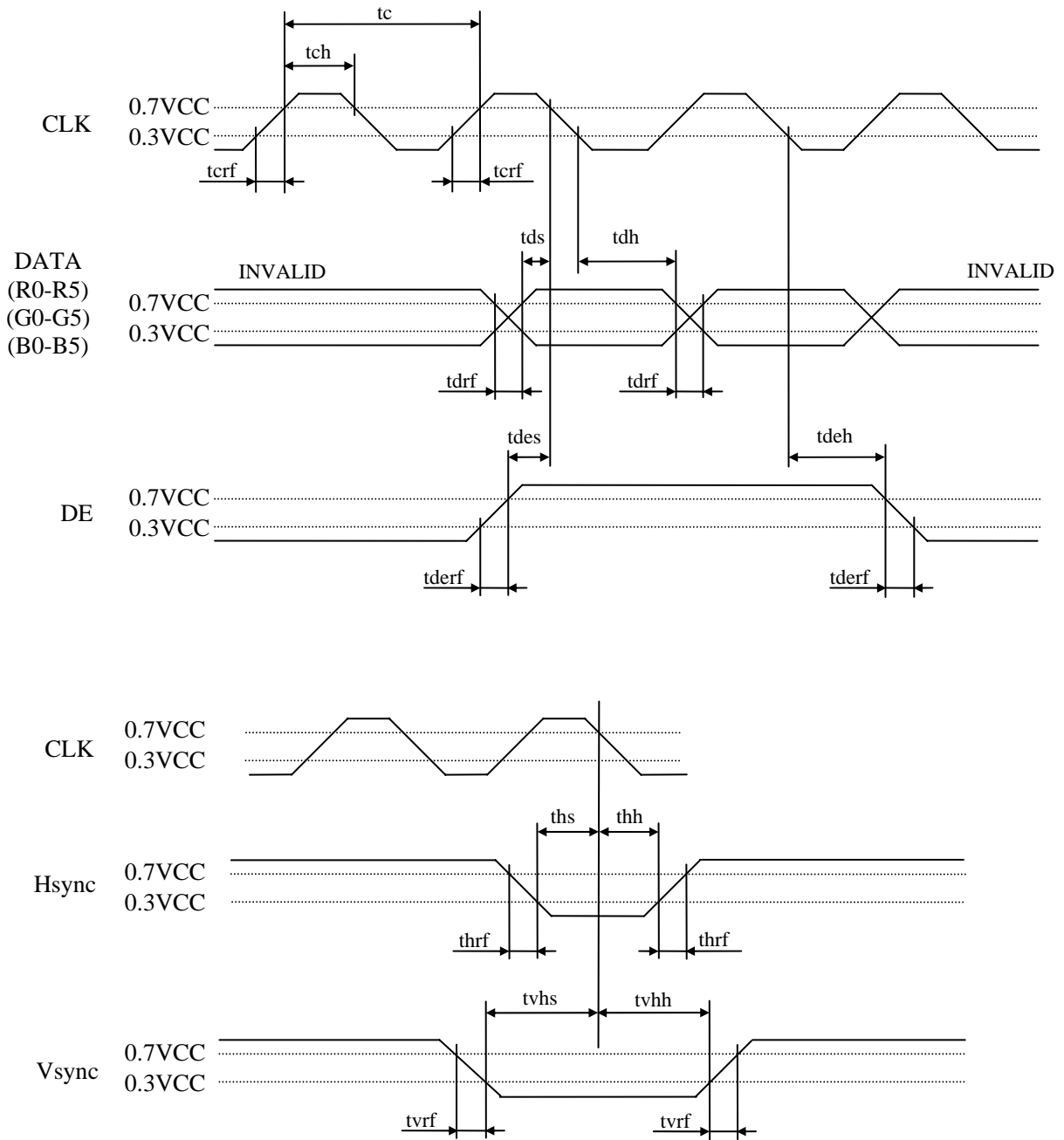

4.9 OPTICS

4.9.1 Optical characteristics

(Note1, Note2)

Parameter	Condition	Symbol	min.	typ.	max.	Unit	Measuring instrument	Remarks	
Luminance	White at center $\theta R=0^\circ, \theta L=0^\circ, \theta U=0^\circ, \theta D=0^\circ$	L	500	800	-	cd/m <sup>2</sup>	BM-5A	-	
Contrast ratio	White/Black at center $\theta R=0^\circ, \theta L=0^\circ, \theta U=0^\circ, \theta D=0^\circ$	CR	550	850	-	-	BM-5A	Note3	
Luminance uniformity	White $\theta R=0^\circ, \theta L=0^\circ, \theta U=0^\circ, \theta D=0^\circ$	LU	-	1.25	1.4	-	BM-5A	Note4	
Chromaticity	White	x coordinate	Wx	0.250	0.300	0.350	-	SR-3	Note5
		y coordinate	Wy	0.300	0.350	0.400	-		
	Red	x coordinate	Rx	-	0.640	-	-		
		y coordinate	Ry	-	0.335	-	-		
	Green	x coordinate	Gx	-	0.310	-	-		
		y coordinate	Gy	-	0.580	-	-		
Blue	x coordinate	Bx	-	0.135	-	-			
	y coordinate	By	-	0.135	-	-			
Color gamut	$\theta R=0^\circ, \theta L=0^\circ, \theta U=0^\circ, \theta D=0^\circ$ at center, against NTSC color space	C	55	60	-	%			
Response time	White to Black	Ton	-	3	5	ms	BM-5A	Note6	
	Black to White	Toff	-	15	21	ms		Note7	
Viewing angle	Right	$\theta U=0^\circ, \theta D=0^\circ, CR \geq 10$	$\theta R$	70	80	-	EZ Contrast	Note8	
	Left	$\theta U=0^\circ, \theta D=0^\circ, CR \geq 10$	$\theta L$	70	80	-			
	Up	$\theta R=0^\circ, \theta L=0^\circ, CR \geq 10$	$\theta U$	70	80	-			
	Down	$\theta R=0^\circ, \theta L=0^\circ, CR \geq 10$	$\theta D$	70	80	-			

Note1: These are initial characteristics.

Note2: Measurement conditions are as follows.

Ta= 25°C, VCC= 3.3V, IL= 25mA/One circuit, Display mode: VGA, Horizontal cycle= 1/31.468kHz, Vertical cycle= 1/59.94Hz, DPSH/DPSV= Low or Open /High or Open: Normal scan

Optical characteristics are measured at luminance saturation 20minutes after the product works in the dark room. Also measurement methods are as follows.

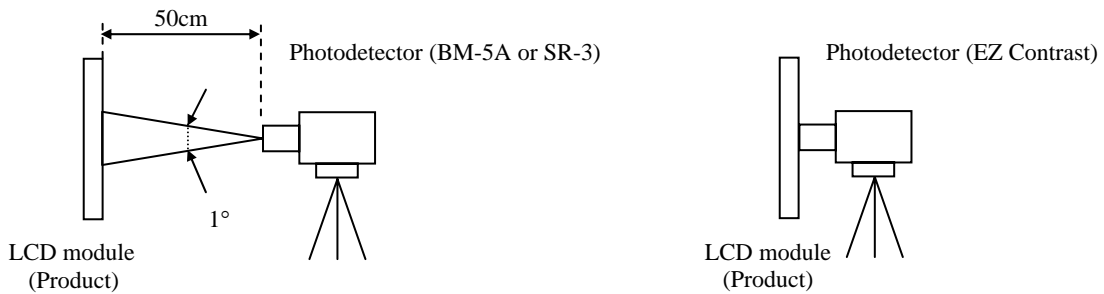

Note3: See "4.9.2 Definition of contrast ratio".

Note4: See "4.9.3 Definition of luminance uniformity".

Note5: These coordinates are found on CIE 1931 chromaticity diagram.

Note6: Product surface temperature: TopF= 29°C

Note7: See "4.9.4 Definition of response times".

Note8: See "4.9.5 Definition of viewing angles".

4.9.2 Definition of contrast ratio

The contrast ratio is calculated by using the following formula.

$$\text{Contrast ratio (CR)} = \frac{\text{Luminance of white screen}}{\text{Luminance of black screen}}$$

4.9.3 Definition of luminance uniformity

The luminance uniformity is calculated by using following formula.

$$\text{Luminance uniformity (LU)} = \frac{\text{Maximum luminance from ① to ⑤}}{\text{Minimum luminance from ① to ⑤}}$$

The luminance is measured at near the 5 points shown below.

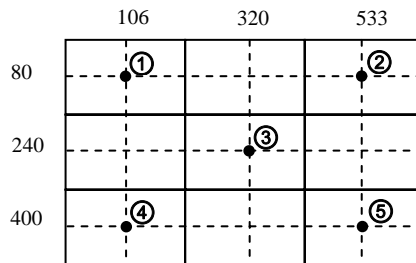

4.9.4 Definition of response times

Response time is measured at the time when the luminance changes from "white" to "black", or "black" to "white" on the same screen point, by photo-detector. Ton is the time when the luminance changes from 90% down to 10%. Also Toff is the time when the luminance changes from 10% up to 90% (See the following diagram.).

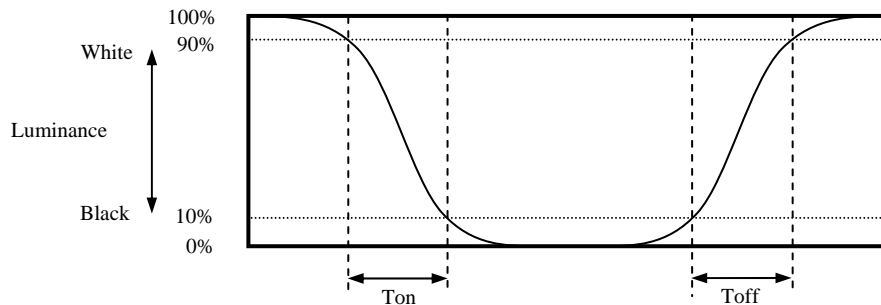

4.9.5 Definition of viewing angles

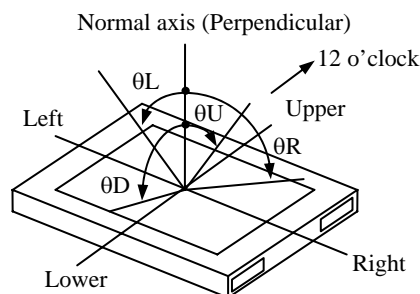



**5. ESTIMATED LUMINANCE LIFETIME**

The luminance lifetime is the time from initial luminance to half-luminance.

**This lifetime is the estimated value, and is not guarantee value.**

Condition		Estimated luminance lifetime (Life time expectancy) Note1, Note2, Note3	Unit
LED elementary substance	25°C (Ambient temperature of LED) Continuous operation, IL= 25mA / One circuit	50,000	h

Note1: Life time expectancy is mean time to half-luminance.

Note2: Estimated luminance lifetime is not the value for an LCD module but the value for LED elementary substance.

Note3: By ambient temperature, the lifetime changes particularly. Especially, in case the product works under high temperature environment, the lifetime becomes short.

6. RELIABILITY TESTS

Test item	Condition	Judgment	Note1
High temperature and humidity (Operation)	① 60 ± 2°C, RH= 90%, 240hours ② Display data is black.	No display malfunctions	
High temperature (Operation)	① 80 ± 3°C, 240hours ② Display data is black.		
Heat cycle (Operation)	① -30 ± 3°C...1hour 80 ± 3°C...1hour ② 50cycles, 4 hours/cycle ③ Display data is black.		
Thermal shock (Non operation)	① -30 ± 3°C...30minutes 80 ± 3°C...30minutes ② 100cycles, 1hour/cycle ③ Temperature transition time is within 5 minutes.		
ESD (Operation)	① 150pF, 150Ω, ±10kV ② 9 places on a panel surface Note2 ③ 10 times each places at 1 sec interval		
Dust (Operation)	① Sample dust: No. 15 (by JIS-Z8901) ② 15 seconds stir ③ 8 times repeat at 1 hour interval		
Vibration (Non operation)	① 5 to 100Hz, 19.6m/s <sup>2</sup> ② 1 minute/cycle ③ X, Y, Z directions ④ 120 times each directions		
Mechanical shock (Non operation)	① 539m/ s <sup>2</sup> , 11ms ② ±X, ±Y, ±Z directions ③ 5 times each directions		

Note1: Display and appearance are checked under environmental conditions equivalent to the inspection conditions of defect criteria.

Note2: See the following figure for discharge points.

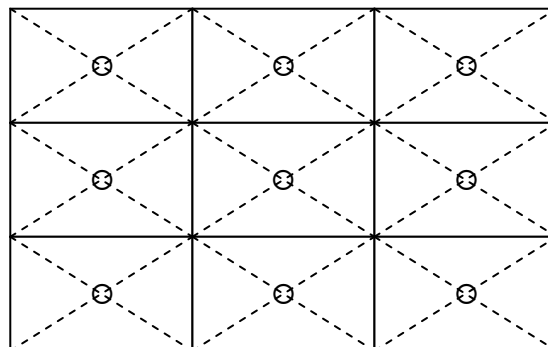

7. PRECAUTIONS

7.1 MEANING OF CAUTION SIGNS

The following caution signs have very important meaning. **Be sure to read "7.2 CAUTIONS" and "7.3 ATTENTIONS"!**

	This sign has the meaning that a customer will be injured or the product will sustain damage if the customer practices wrong operations.
---	--

	This sign has the meaning that a customer will be injured if the customer practices wrong operations.
---	---

7.2 CAUTIONS

	<p><b>* Do not shock and press the LCD panel and the backlight! There is a danger of breaking, because they are made of glass. (Shock: Equal to or no greater than 539m/s<sup>2</sup> and equal to or no greater than 11ms, Pressure: Equal to or no greater than 19.6N (φ16mm jig))</b></p>
---	--

7.3 ATTENTIONS 

7.3.1 Handling of the product

- ① Take hold of both ends without touching the circuit board when the product (LCD module) is picked up from inner packing box to avoid broken down or misadjustment, because of stress to mounting parts on the circuit board.
- ② When the product is put on the table temporarily, display surface must be placed downward.
- ③ When handling the product, take the measures of electrostatic discharge with such as earth band, ionic shower and so on, because the product may be damaged by electrostatic.
- ④ The torque for product mounting screws must never exceed 0.147N·m. Higher torque might result in distortion of the bezel.
- ⑤ The product must be installed using mounting holes without undue stress such as bends or twist (See outline drawings). And do not add undue stress to any portion (such as bezel flat area). Bends or twist described above and undue stress to any portion may cause display mura.
- ⑥ Do not press or rub on the sensitive product surface. When cleaning the product surface, wipe it with a soft dry cloth.
- ⑦ Do not push or pull the interface connectors while the product is working.
- ⑧ When handling the product, use of an original protection sheet on the product surface (polarizer) is recommended for protection of product surface. Adhesive type protection sheet may change color or characteristics of the polarizer.
- ⑨ Usually liquid crystals don't leak through the breakage of glasses because of the surface tension of thin layer and the construction of LCD panel. But, if you contact with liquid crystal by any chance, please wash it away with soap and water.

7.3.2 Environment

- ① Do not operate or store in high temperature, high humidity, dewdrop atmosphere or corrosive gases. Keep the product in packing box with antistatic pouch in room temperature to avoid dusts and sunlight, when storing the product.
- ② In order to prevent dew condensation occurred by temperature difference, the product packing box must be opened after enough time being left under the environment of an unpacking room. Evaluate the storage time sufficiently because dew condensation is affected by the environmental temperature and humidity. (Recommended leaving time: 6 hours or more with the original packing state after a customer receives the package)
- ③ Do not operate in high magnetic field. If not, circuit boards may be broken.
- ④ This product is not designed as radiation hardened.

7.3.3 Characteristics

**The following items are neither defects nor failures.**

- ① Response time, luminance and color may be changed by ambient temperature.
- ② Display mura, flickering, vertical streams or tiny spots may be observed depending on display patterns.
- ③ Do not display the fixed pattern for a long time because it may cause image sticking. Use a screen saver, if the fixed pattern is displayed on the screen.
- ④ The display color may be changed depending on viewing angle because of the use of condenser sheet in the backlight.
- ⑤ Optical characteristics may be changed depending on input signal timings.

7.3.4 Others

- ① All GND and VCC terminals should be used without any non-connected lines.
- ② Do not disassemble a product or adjust variable resistors.
- ③ See "REPLACEMENT MANUAL FOR LAMP HOLDER SET", when replacing LED backlight lamps.
- ④ Pack the product with the original shipping package, in order to avoid any damages during transportation, when returning the product to NEC for repairing and so on.
- ⑤ The information of China RoHS directive six hazardous substances or elements in this product is as follows.

China RoHS directive six hazardous substances or elements					
Lead (Pb)	Mercury (Hg)	Cadmium (Cd)	Hexavalent Chromium (Cr VI)	Polybrominated Biphenyls (PBB)	Polybrominated Biphenyl Ethers (PBDE)
×	○	○	○	○	○

Note1: ○: This indicates that the poisonous or harmful material in all the homogeneous materials for this part is equal or below the limitation level of SJ/T11363-2006 standard regulation.

×: This indicates that the poisonous or harmful material in all the homogeneous materials for this part is above the limitation level of SJ/T11363-2006 standard regulation.

8. OUTLINE DRAWINGS

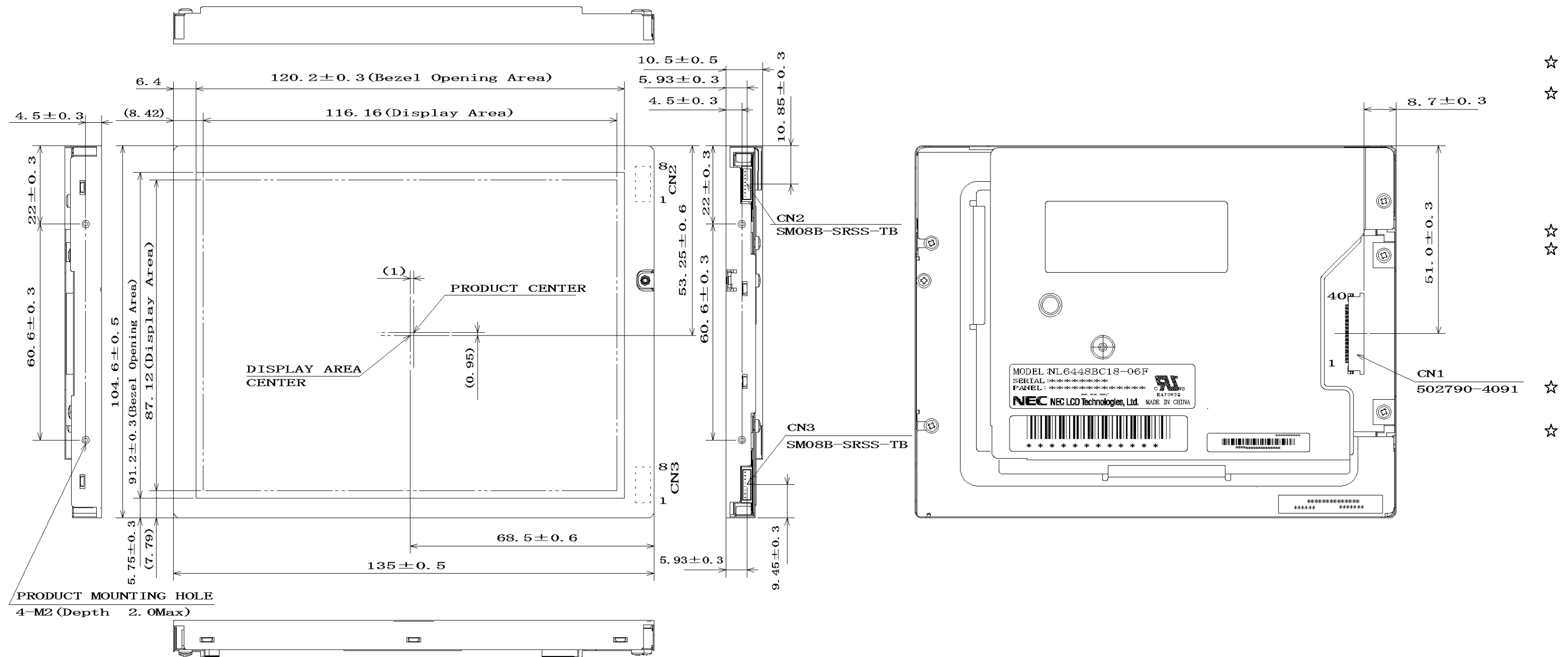

Note1: The values in parentheses are for reference.  
 Note2: The torque for product mounting screws must never exceed 0.147N·m.

Unit: mm